

UKSP206H ABC

Ball bearing units

TYPE: Housing units, Conveyor belt tensioner unit, Radial insert ball bearing with adapter sleeve, With inner ring extended on both sides

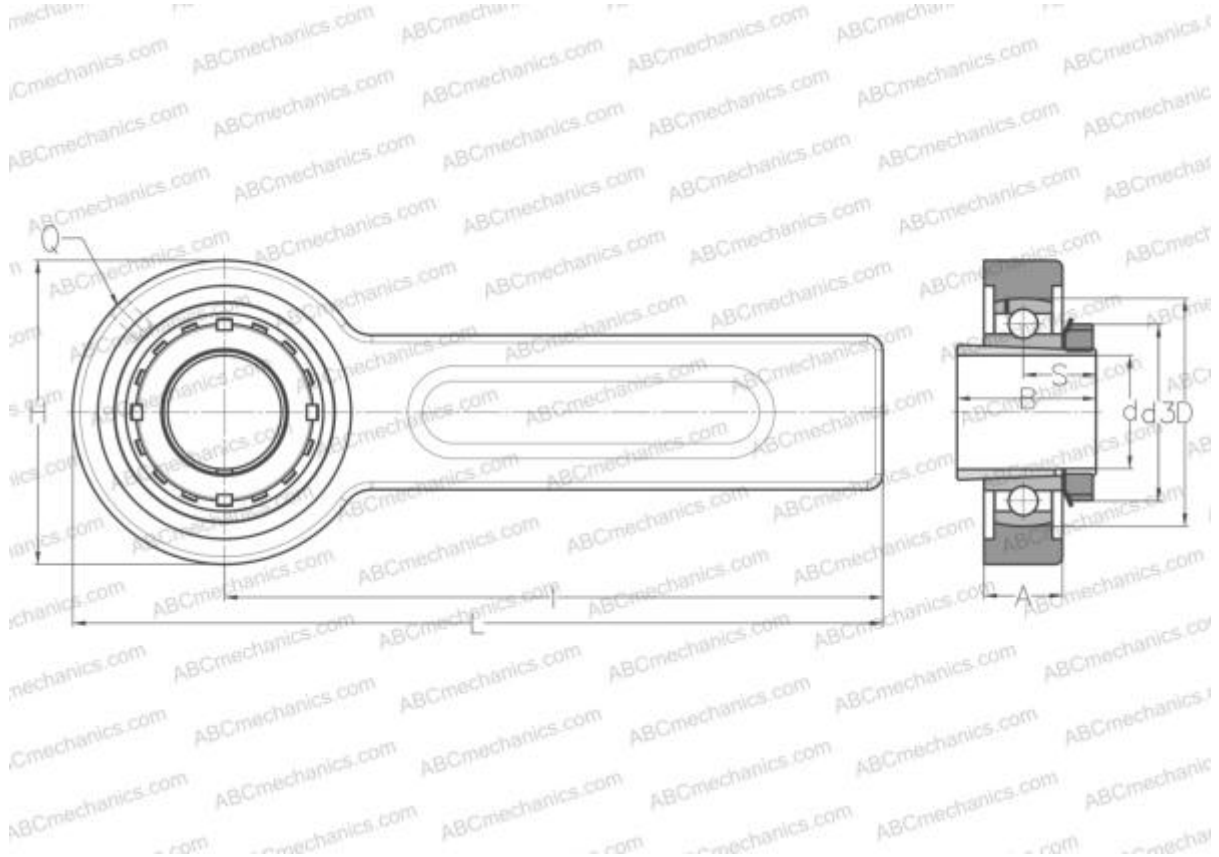

Technical specification

DIMENSIONS, MM

d	25,000
D	62,000
B	38,000
L	274,000
H	98,000
A	21,000
H1	41,000
S	20,500
I	225,000
Q	R1/8"

WEIGHT, KG

2,000

Bearing	UK206 +
Housing	06-207/62

Adapter sleeve

H2306

MANUFACTURER

[ABC](#)

INTERCHANGE

SNR

[UKSP206H](#)