

UKSP207H SNR

Ball bearing units

TYPE: Housing units, Conveyor belt tensioner unit, Radial insert ball bearing with adapter sleeve, With inner ring extended on both sides

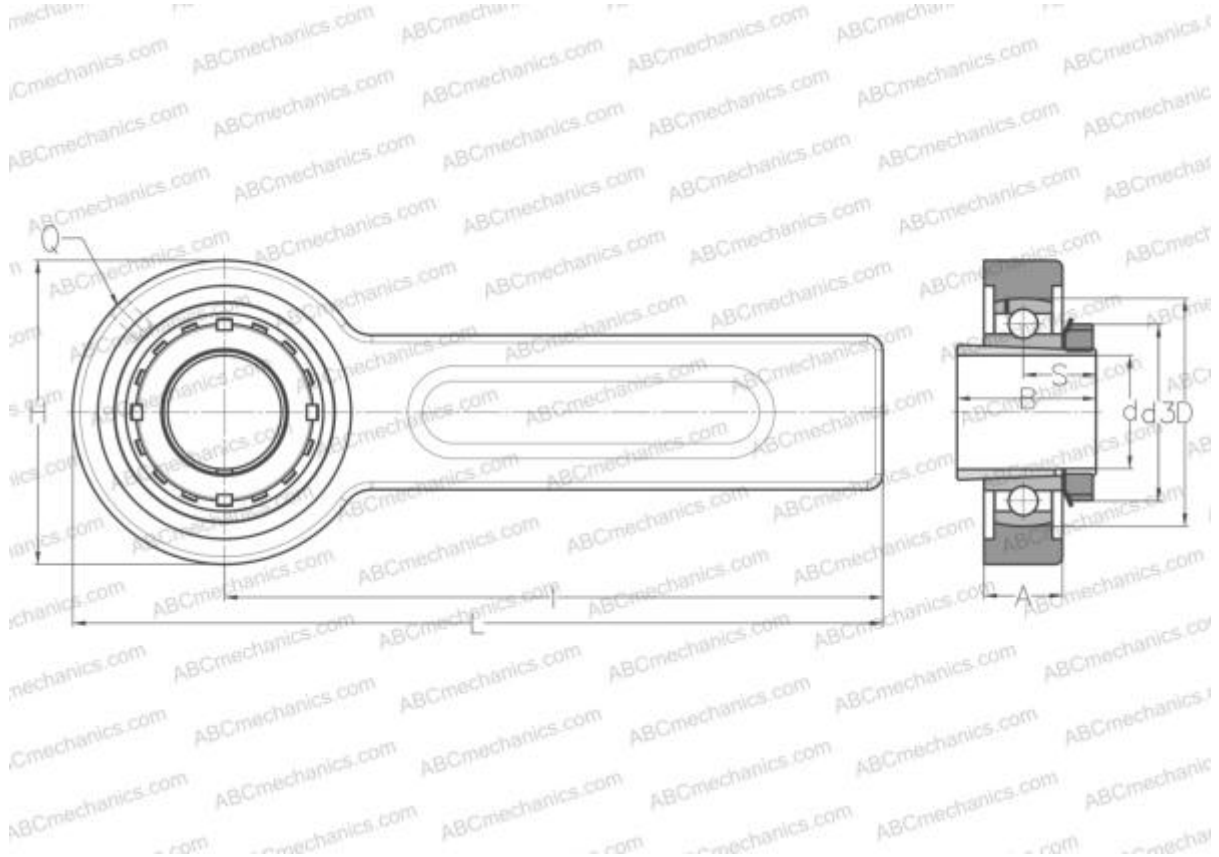

Technical specification

DIMENSIONS, MM

d	30,000
D	72,000
B	43,000
L	274,000
H	98,000
A	21,000
H1	41,000
S	22,500
I	225,000
Q	R1/8"

WEIGHT, KG

2,100

Bearing	UK207 +
Housing	06-207/72

Adapter sleeve H2307

MANUFACTURER

[SNR](#)

INTERCHANGE

ABC [UKSP207H](#)

CALCULATION DATA

Basic dynamic load rating, C	25,700 kN
Basic static load rating, Co	15,200 kN
Operating temperature min	-20 °C
Operating temperature max	110 °C