

## UKSP209H ABC

Ball bearing units

TYPE: Housing units, Conveyor belt tensioner unit, Radial insert ball bearing with adapter sleeve, With inner ring extended on both sides

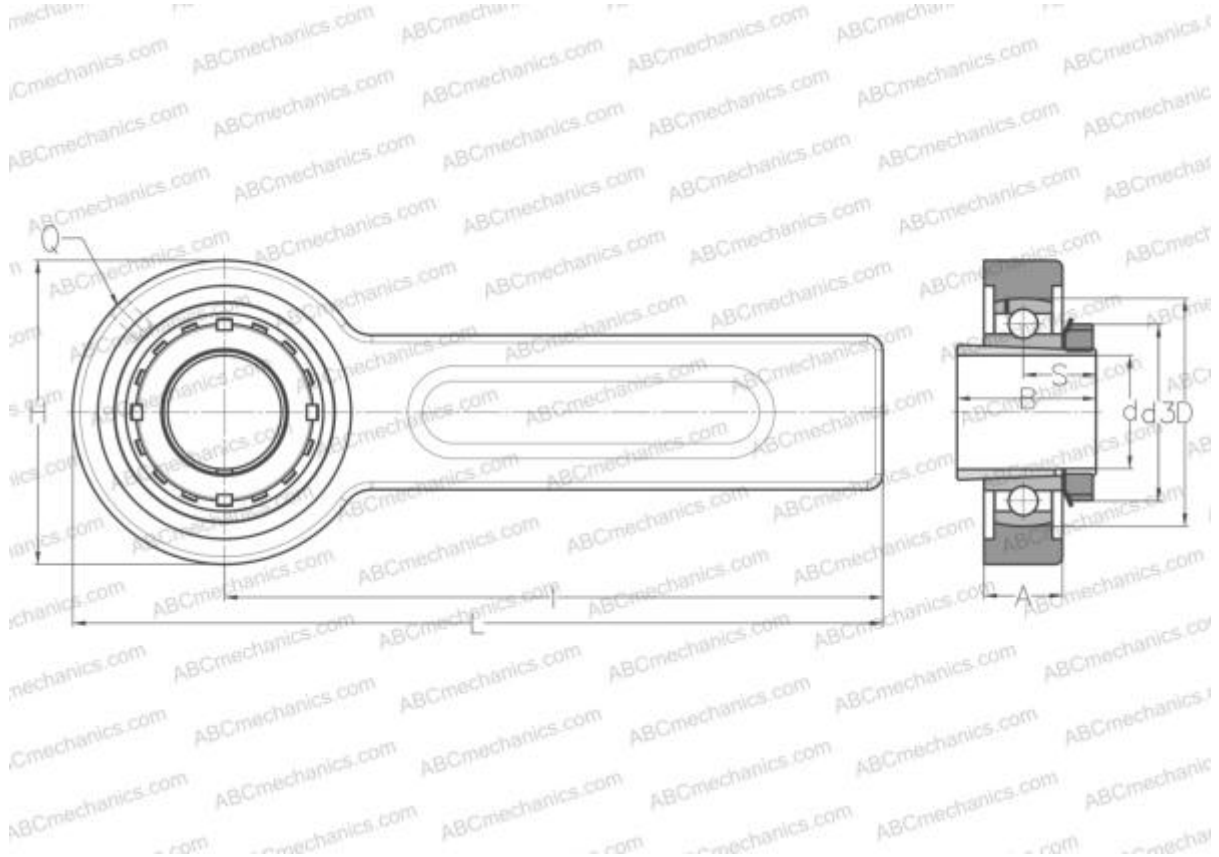

### Technical specification

#### DIMENSIONS, MM

d	40,000
D	85,000
B	50,000
L	320,000
H	120,000
A	31,000
H1	61,000
S	26,000
I	260,000
Q	R1/8"

#### WEIGHT, KG

4,300

Bearing	UK209 +
Housing	08-210/85

Adapter sleeve

H2309

#### MANUFACTURER

[ABC](#)

#### INTERCHANGE

SNR

[UKSP209H](#)