

UKSP209H SNR

Ball bearing units

TYPE: Housing units, Conveyor belt tensioner unit, Radial insert ball bearing with adapter sleeve, With inner ring extended on both sides

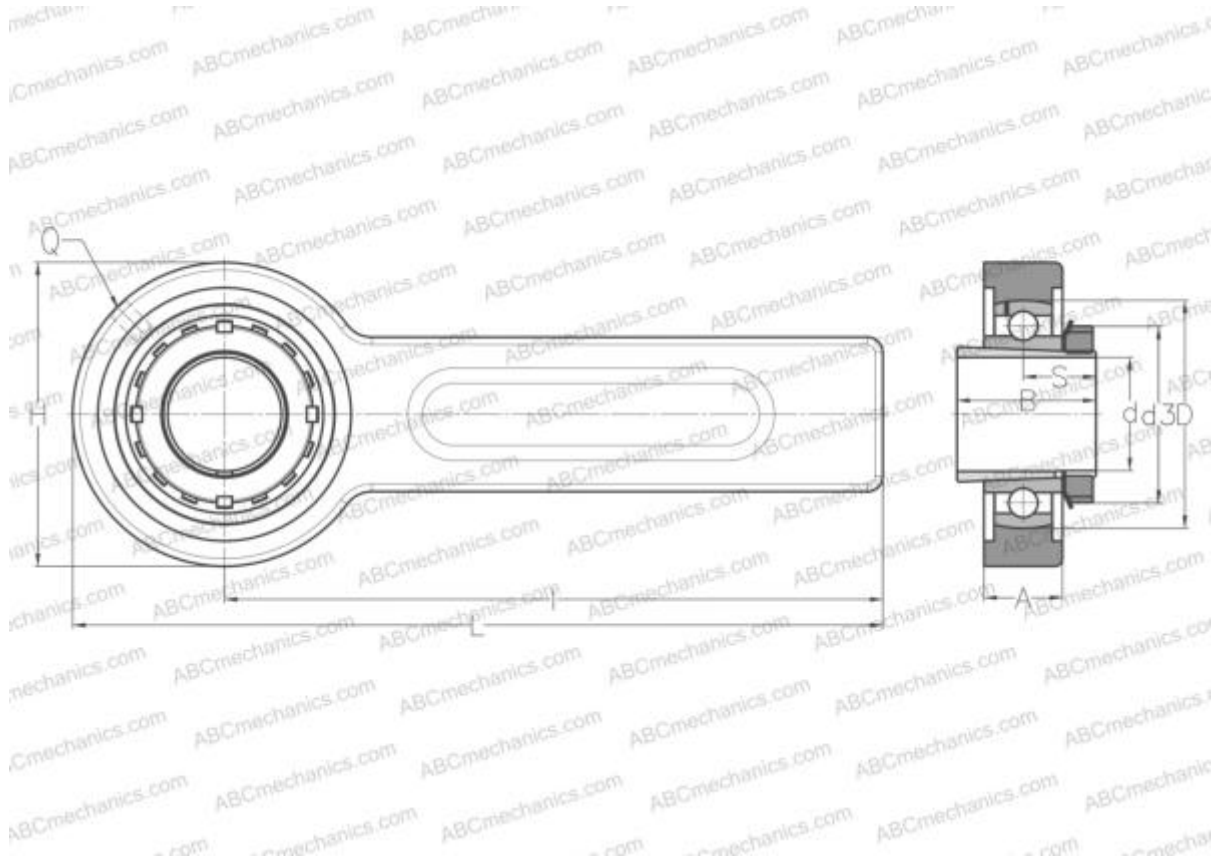

Technical specification

DIMENSIONS, MM

d	40,000
D	85,000
B	50,000
L	320,000
H	120,000
A	31,000
H1	61,000
S	26,000
I	260,000
Q	R1/8"

WEIGHT, KG

4,300

Bearing	UK209 +
Housing	08-210/85

Adapter sleeve

H2309

MANUFACTURER

[SNR](#)

INTERCHANGE

ABC

[UKSP209H](#)

CALCULATION DATA

Basic dynamic load rating, C	31,850 kN
Basic static load rating, Co	20,800 kN
Operating temperature min	-20 °C
Operating temperature max	110 °C