

EXC202 SNR

Ball bearing units

TYPE: Housing units, Cartridge units, Cast iron housing, Radial insert ball bearing with eccentric locking collar, With inner ring extended on both sides

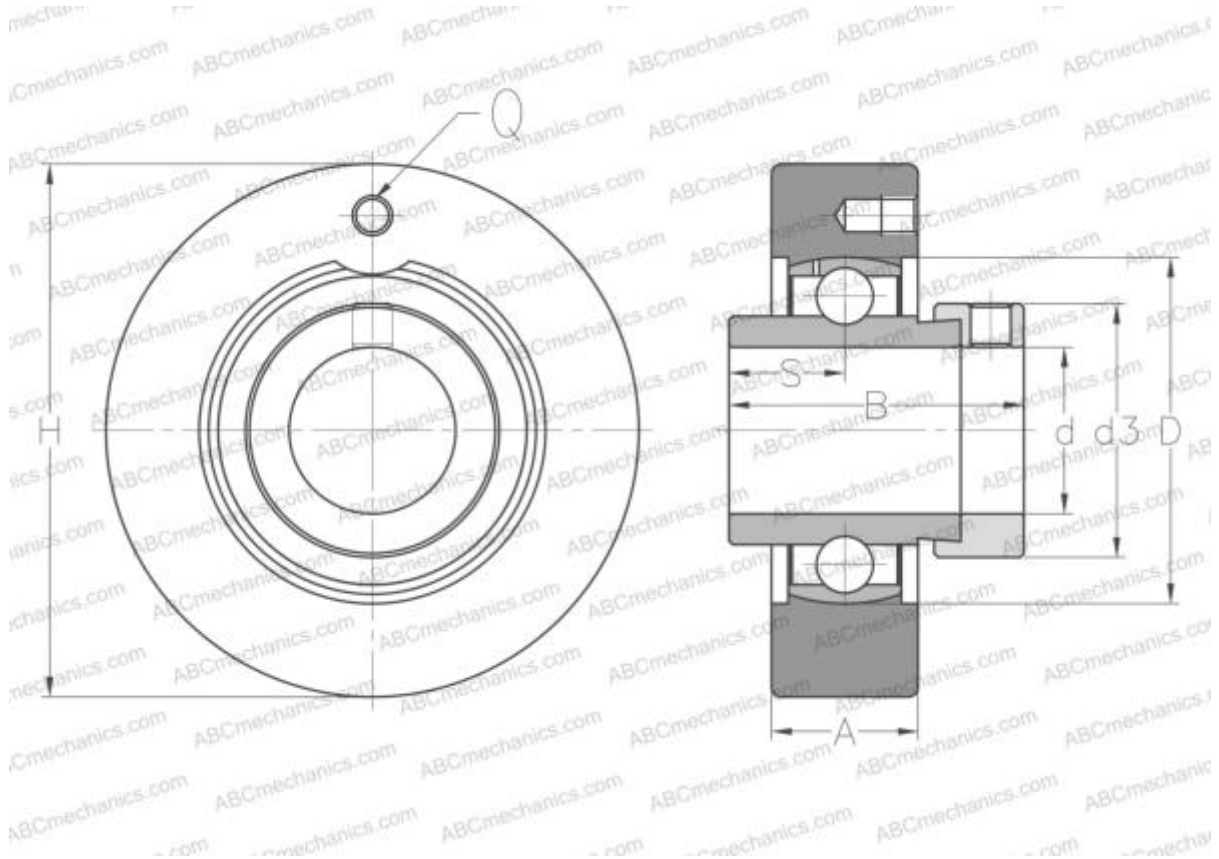

Technical specification

DIMENSIONS, MM

d	15,000
D	47,000
B	43,500
H	72,000
A	20,000
S	17,000
d3	33,300
Q	M6x1

WEIGHT, KG

Bearing	EX202
Housing	C204

MANUFACTURER

[SNR](#)

INTERCHANGE

ABC

[EXC202](#)

CALCULATION DATA

Basic dynamic load rating, C	12,800 kN
Basic static load rating, Co	6,650 kN
Operating temperature min	-20 °C
Operating temperature max	110 °C