

EXC203 ABC

Ball bearing units

TYPE: Housing units, Cartridge units, Cast iron housing, Radial insert ball bearing with eccentric locking collar, With inner ring extended on both sides

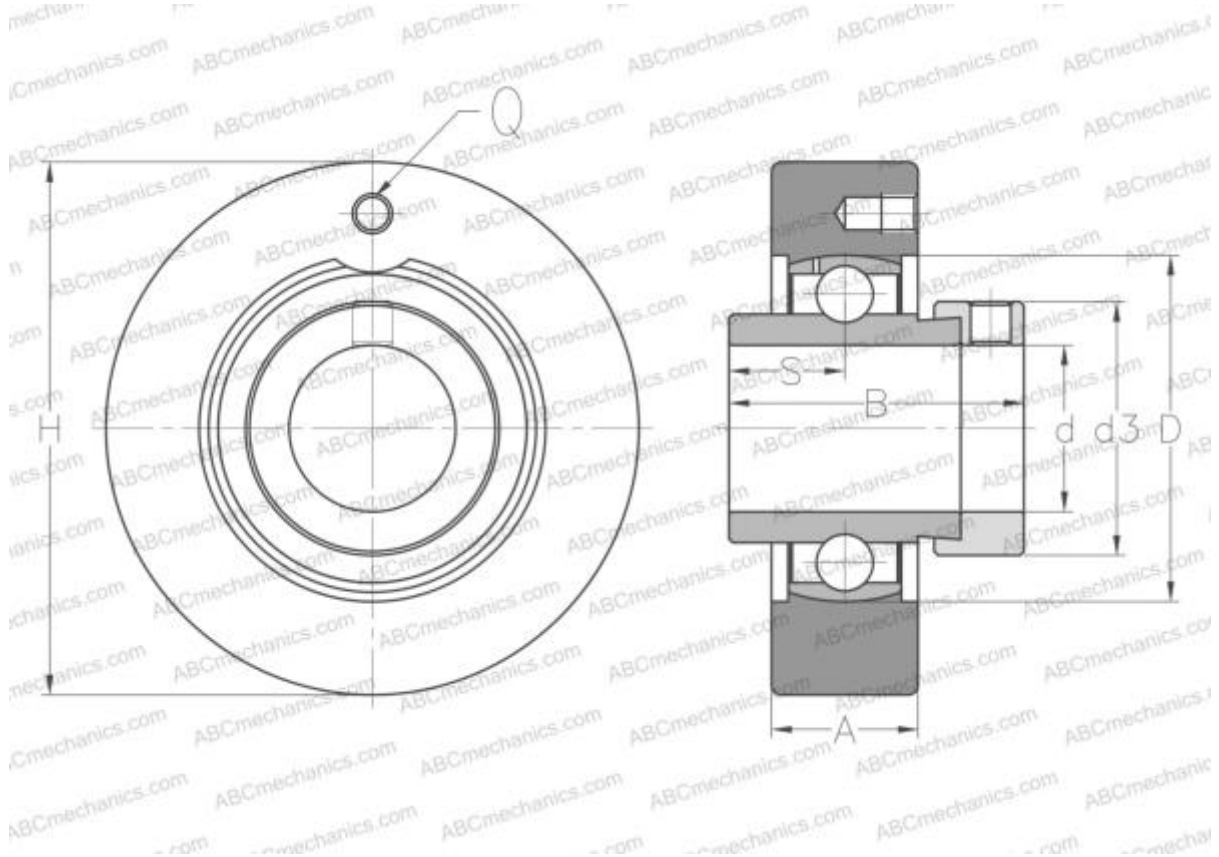

Technical specification

DIMENSIONS, MM

d	17,000
D	47,000
B	43,500
H	72,000
A	20,000
S	17,000
d3	33,300
Q	M6x1

WEIGHT, KG

Bearing	EX203
Housing	C204

MANUFACTURER

[ABC](#)

INTERCHANGE

SNR

[EXC203](#)