

## UCC202 ABC

Ball bearing units

TYPE: Housing units, Cartridge units, Cast iron housing, Radial insert ball bearing with grub screws in inner ring, With inner ring extended on both sides

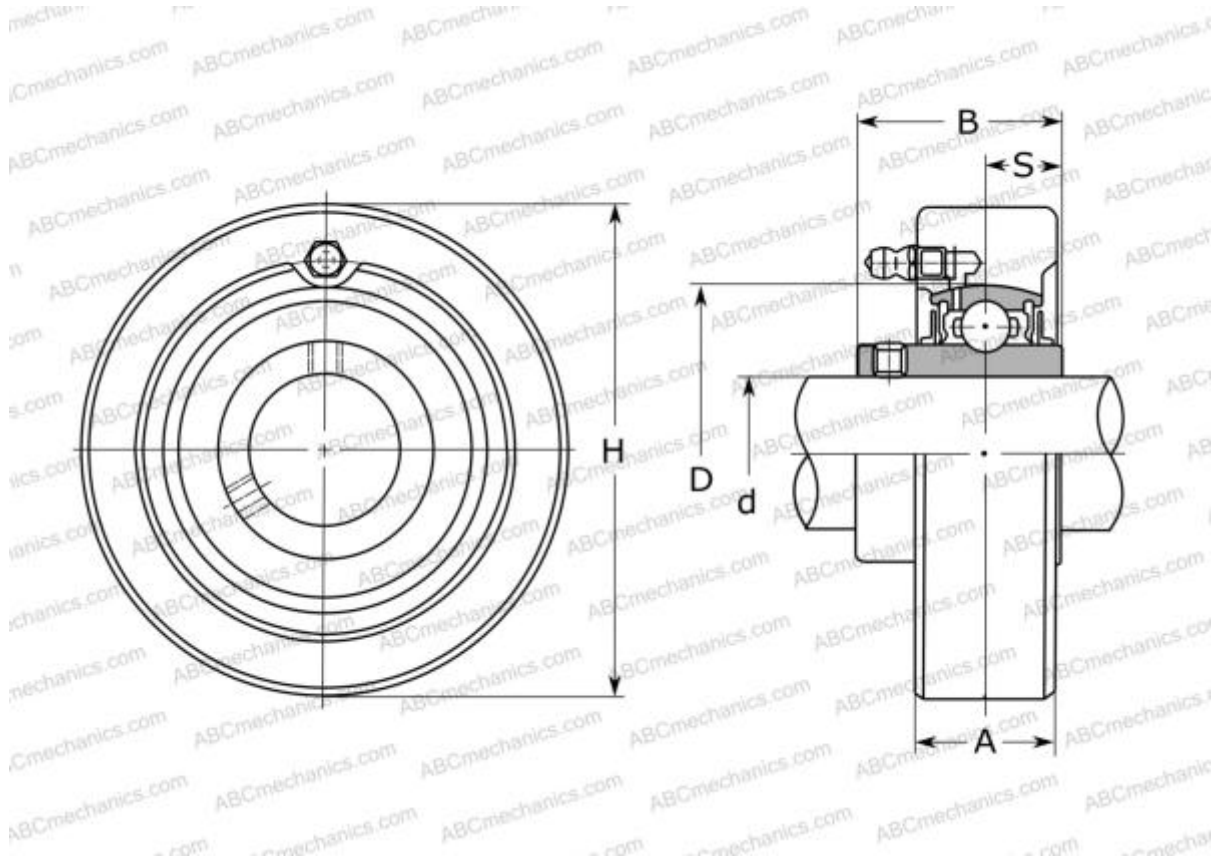

### Technical specification

#### DIMENSIONS, MM

d	15,000
D	47,000
B	31,000
H	72,000
A	20,000
S	12,700
Q	M6x1

#### WEIGHT, KG

	0,500
Bearing	UC202
Housing	C204

#### MANUFACTURER

[ABC](#)

#### INTERCHANGE

ASAHI	<a href="#">UCC 202</a>
SNR	<a href="#">UCC202</a>
SLB	<a href="#">UCC 202</a>
FYH	<a href="#">UCC202</a>
NTN	<a href="#">UCC 202 D1</a>