

## UKC305H SNR

Ball bearing units

TYPE: Housing units, Cartridge units, Cast iron housing, Radial insert ball bearing with adapter sleeve, With inner ring extended on both sides

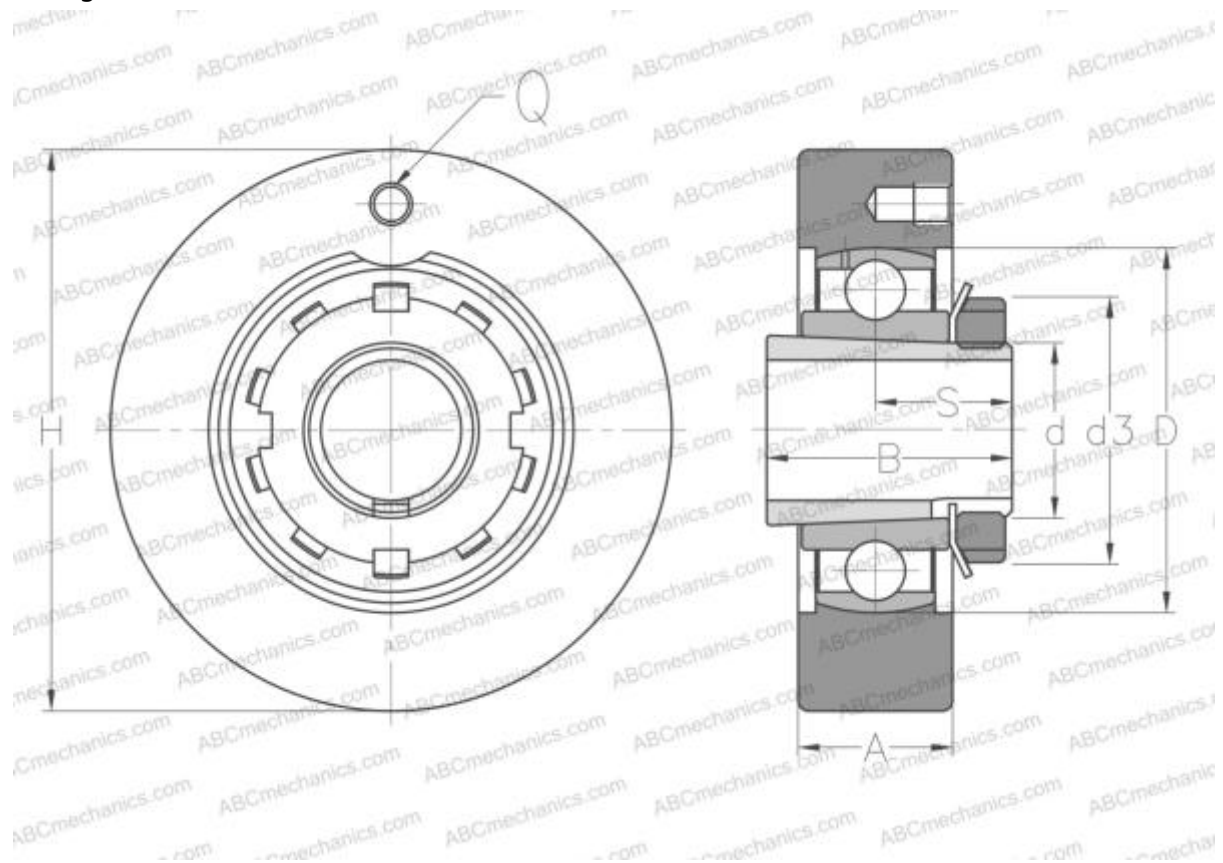

### Technical specification

#### DIMENSIONS, MM

d	20,000
D	62,000
B	35,000
H	90,000
A	26,000
S	21,500
d3	38,000
Q	M6x1

#### WEIGHT, KG

1,500

Bearing	UK305 +
Housing	C305
Adapter sleeve	H2305

#### MANUFACTURER

[SNR](#)

#### INTERCHANGE

ABC

[UKC305H](#)

#### CALCULATION DATA

Basic dynamic load rating, C	22,360 kN
Basic static load rating, Co	11,500 kN
Operating temperature min	-20 °C
Operating temperature max	110 °C