

ESEHE202 ABC

Ball bearing units

TYPE: Housing units, Take-up housing units, Cast iron housing, Radial insert ball bearing with eccentric locking collar, With inner ring extended at one side, bracket

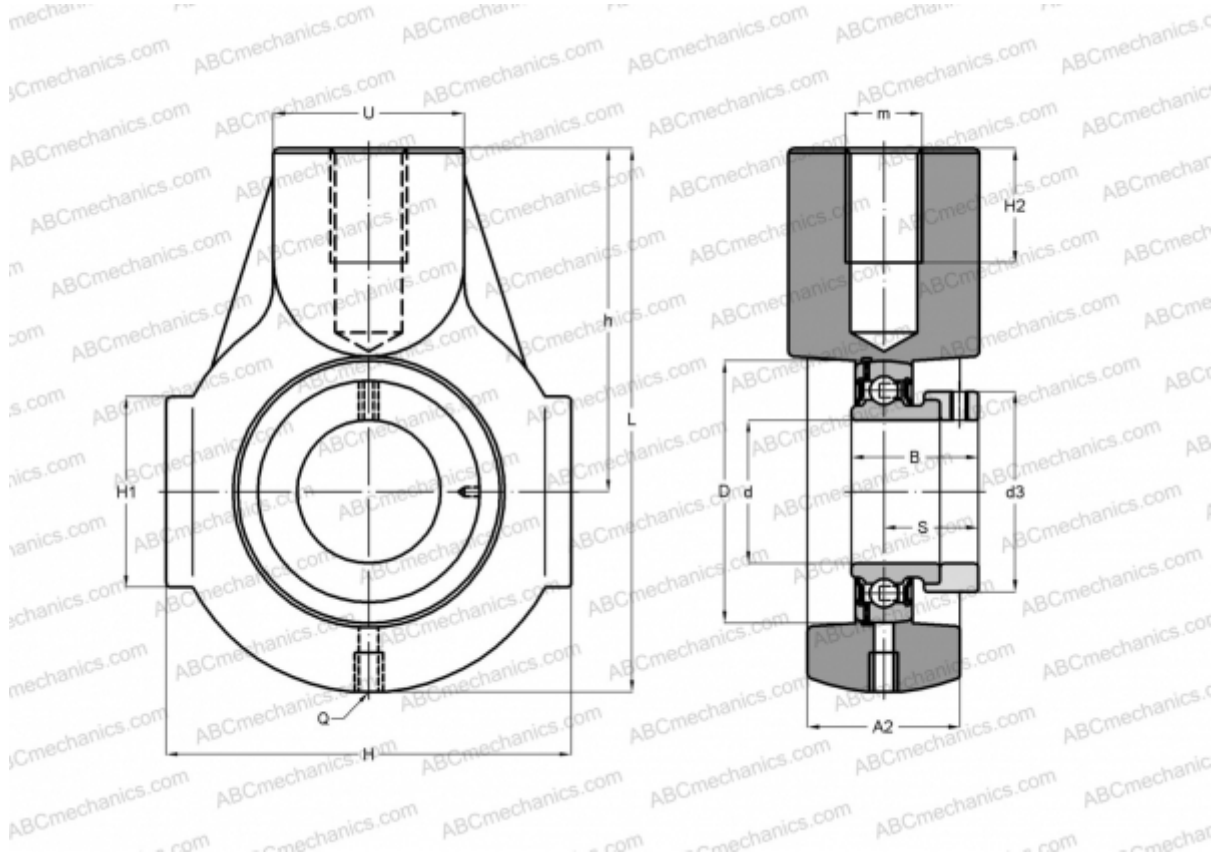

Technical specification

DIMENSIONS, MM

d	15,000
D	40,000
B	28,600
L	91,000
H	65,000
H2	21,000
A2	25,000
H1	38,000
S	6,500
d3	28,600
U	30,000
h	58,000
m	M16
Q	M6x1

WEIGHT, KG

Bearing	0,500
Housing	ES202
	EHE203

MANUFACTURER

[ABC](#)

INTERCHANGE

SNR	ESEHE202
-----	--------------------------