

EXEHE203 SNR

Ball bearing units

TYPE: Housing units, Take-up housing units, Cast iron housing, Radial insert ball bearing with eccentric locking collar, With inner ring extended on both sides, bracket

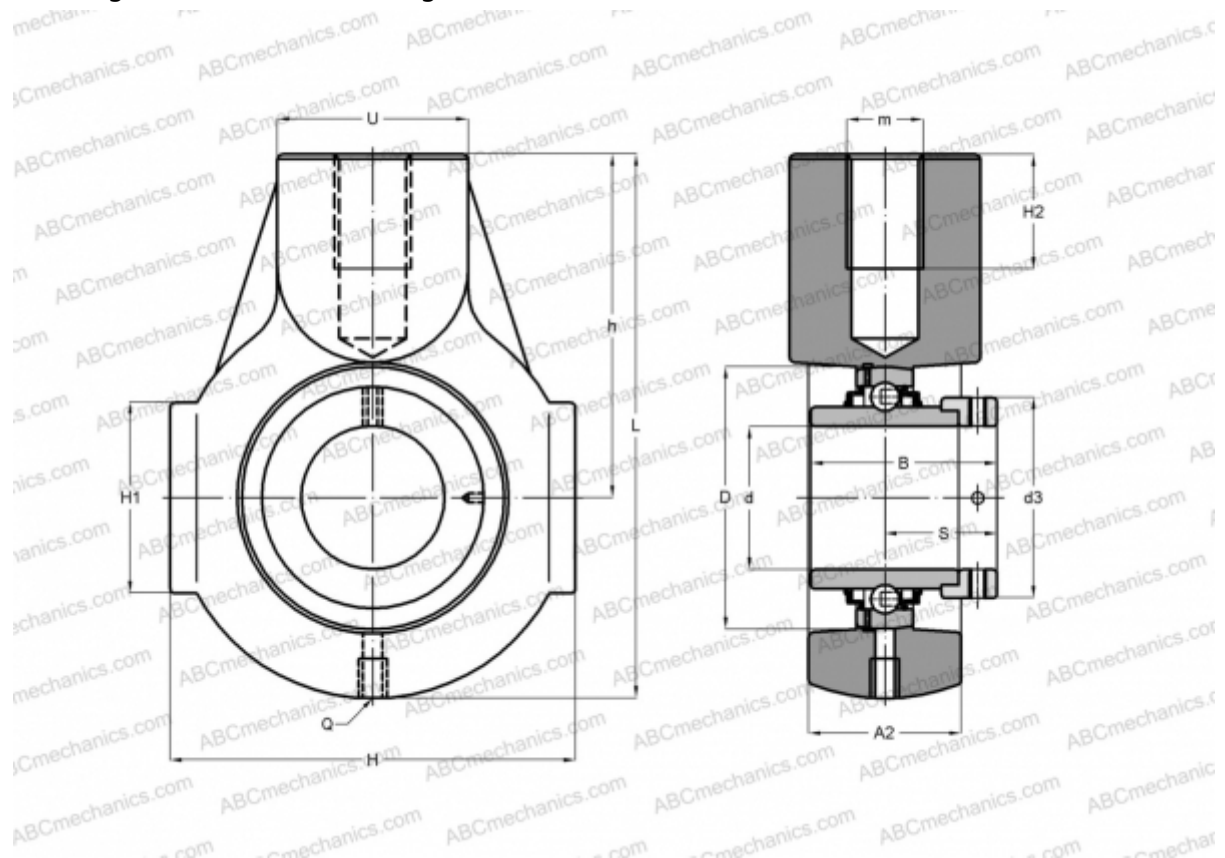

Technical specification

DIMENSIONS, MM

d	17,000
D	47,000
B	43,500
L	91,000
H	65,000
H2	21,000
A2	25,000
H1	38,000
S	17,000
d3	33,300
U	30,000
h	58,000
Q	R1/8"

Bearing	EX203
Housing	EHE204

MANUFACTURER

[SNR](#)

INTERCHANGE

ABC	EXEHE203
-----	--------------------------

CALCULATION DATA

Basic dynamic load rating, C	12,800 kN
Basic static load rating, Co	6,650 kN
Operating temperature min	-20 °C
Operating temperature max	110 °C

WEIGHT, KG	0,800
-------------------	-------