

EXEHE205 ABC

Ball bearing units

TYPE: Housing units, Take-up housing units, Cast iron housing, Radial insert ball bearing with eccentric locking collar, With inner ring extended on both sides, bracket

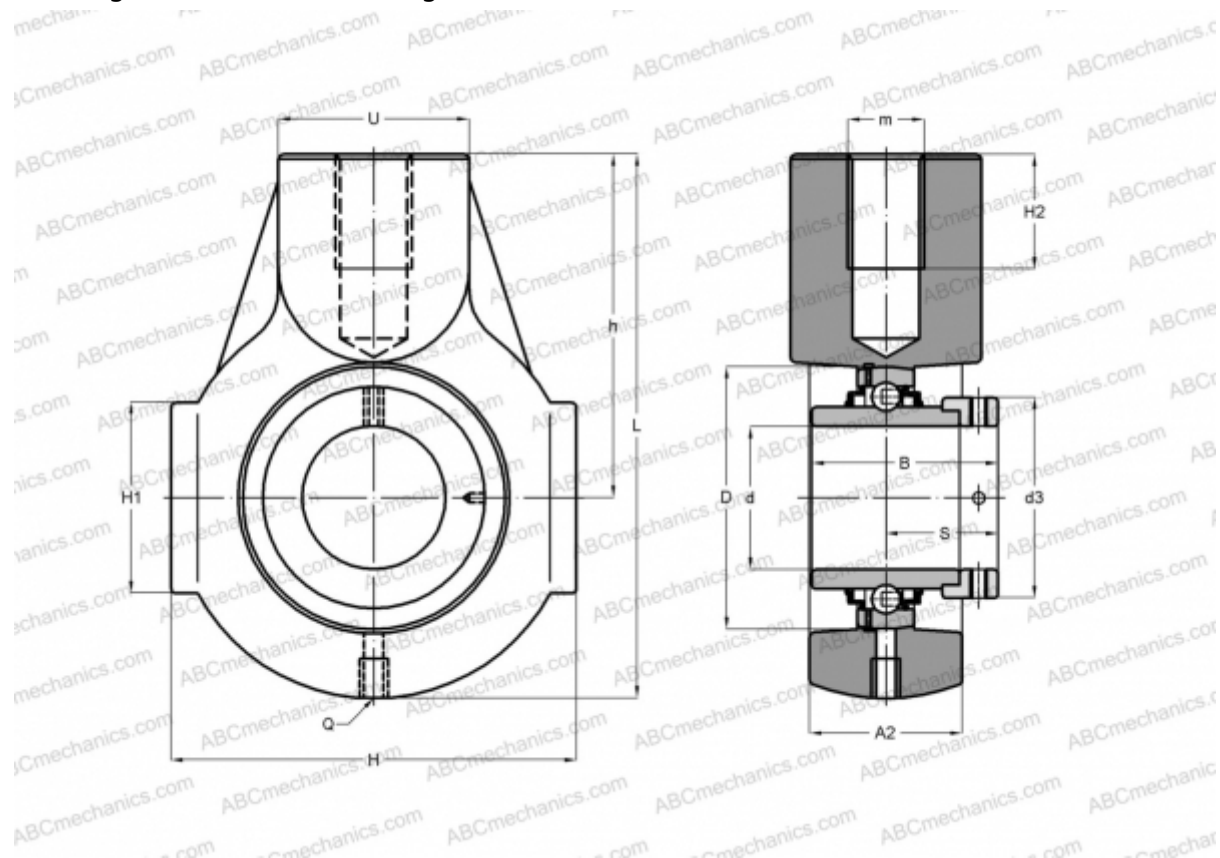

Technical specification

DIMENSIONS, MM

d	25,000
D	52,000
B	44,300
L	99,000
H	70,000
H2	22,000
A2	28,000
H1	38,000
S	17,400
d3	38,100
U	35,000
h	64,000
Q	R1/8"

Bearing	EX205
Housing	EHE205

MANUFACTURER

[ABC](#)

INTERCHANGE

INA	RHE25
SNR	EXEHE205

WEIGHT, KG 1,200