

USEHE205 ABC

Ball bearing units

TYPE: Housing units, Take-up housing units, Cast iron housing, Radial insert ball bearing with grub screws in inner ring, With inner ring extended at one side, bracket

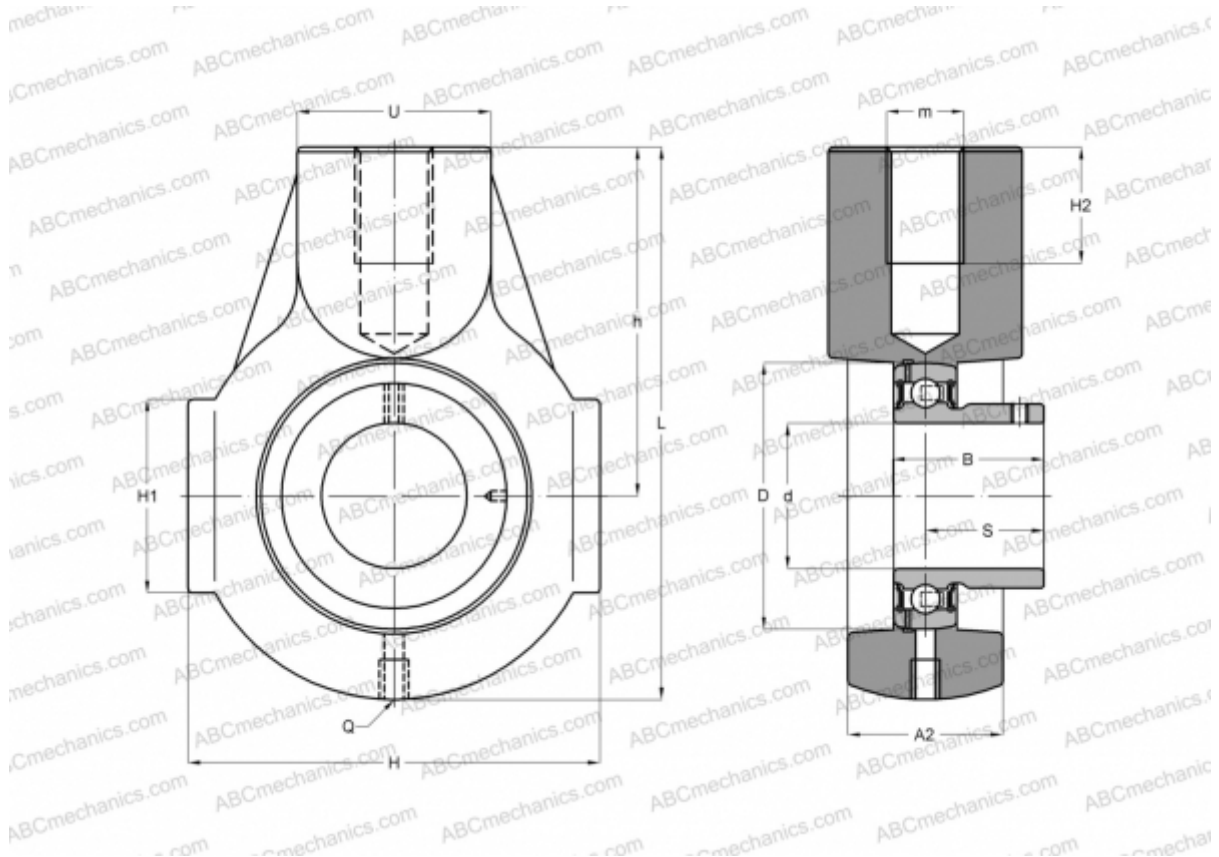

Technical specification

DIMENSIONS, MM

d	25,000
D	52,000
B	27,000
L	99,000
H	70,000
H2	22,000
A2	28,000
H1	38,000
S	7,500
U	35,000
h	64,000
Q	R1/8"

WEIGHT, KG 1,100

Bearing	US205
Housing	EHE205

MANUFACTURER

[ABC](#)

INTERCHANGE

INA	PHEY25
SNR	USEHE205