

UKEHE205H ABC

Ball bearing units

TYPE: Housing units, Take-up housing units, Cast iron housing, Radial insert ball bearing with adapter sleeve, With inner ring extended on both sides, bracket

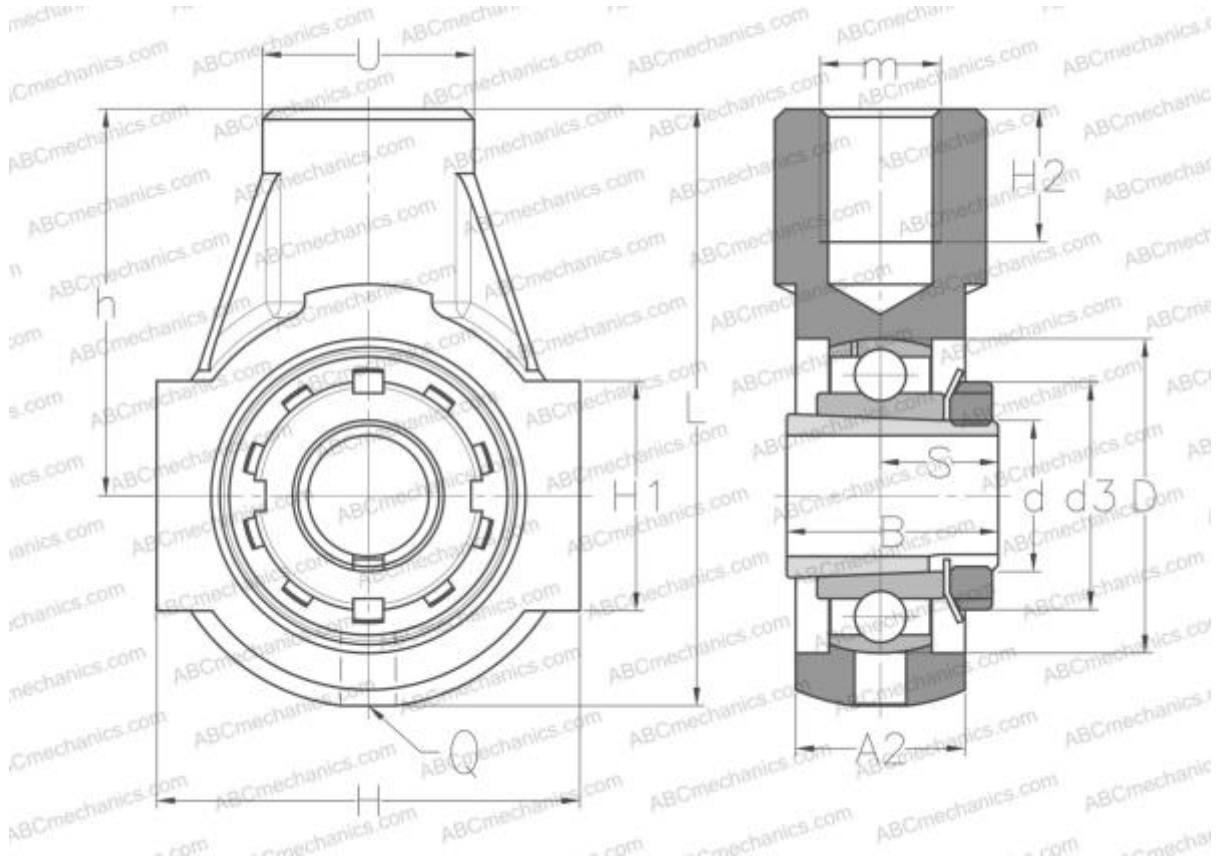

Technical specification

DIMENSIONS, MM

d	20,000
D	52,000
B	35,000
L	99,000
H	70,000
H2	22,000
A2	28,000
H1	38,000
S	18,500
d3	38,000
U	35,000
h	64,000
Q	R1/8"

Bearing	UK205 +
Housing	EHE205
Adapter sleeve	H2305

MANUFACTURER

[ABC](#)

INTERCHANGE

SNR	UKEHE205H
-----	---------------------------

WEIGHT, KG 1,200