

UKEHE206H ABC

Ball bearing units

TYPE: Housing units, Take-up housing units, Cast iron housing, Radial insert ball bearing with adapter sleeve, With inner ring extended on both sides, bracket

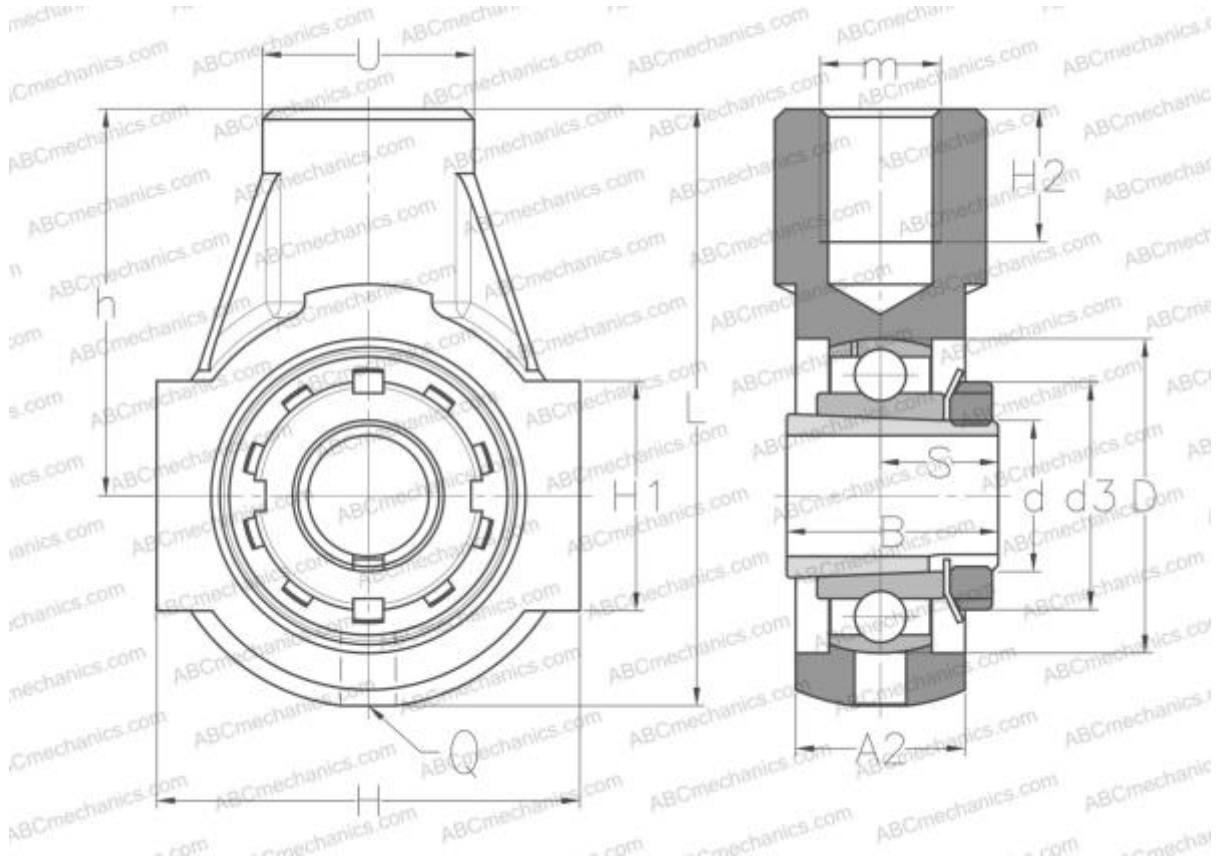

Technical specification

DIMENSIONS, MM

d	25,000
D	62,000
B	38,000
L	114,000
H	85,000
H2	24,000
A2	32,000
H1	40,000
S	20,500
d3	45,000
U	40,000
h	72,000
Q	R1/8"

Bearing	UK206 +
Housing	EHE206
Adapter sleeve	H2306

MANUFACTURER

[ABC](#)

INTERCHANGE

SNR	UKEHE206H
-----	---------------------------

WEIGHT, KG 1,400