

## BPFT 2 ASAHI

Ball bearing units

TYPE: Housing units, Three-bolt flanged housing units, Sheet steel housing, Radial insert ball bearing with grub screws in inner ring, With inner ring extended at one side

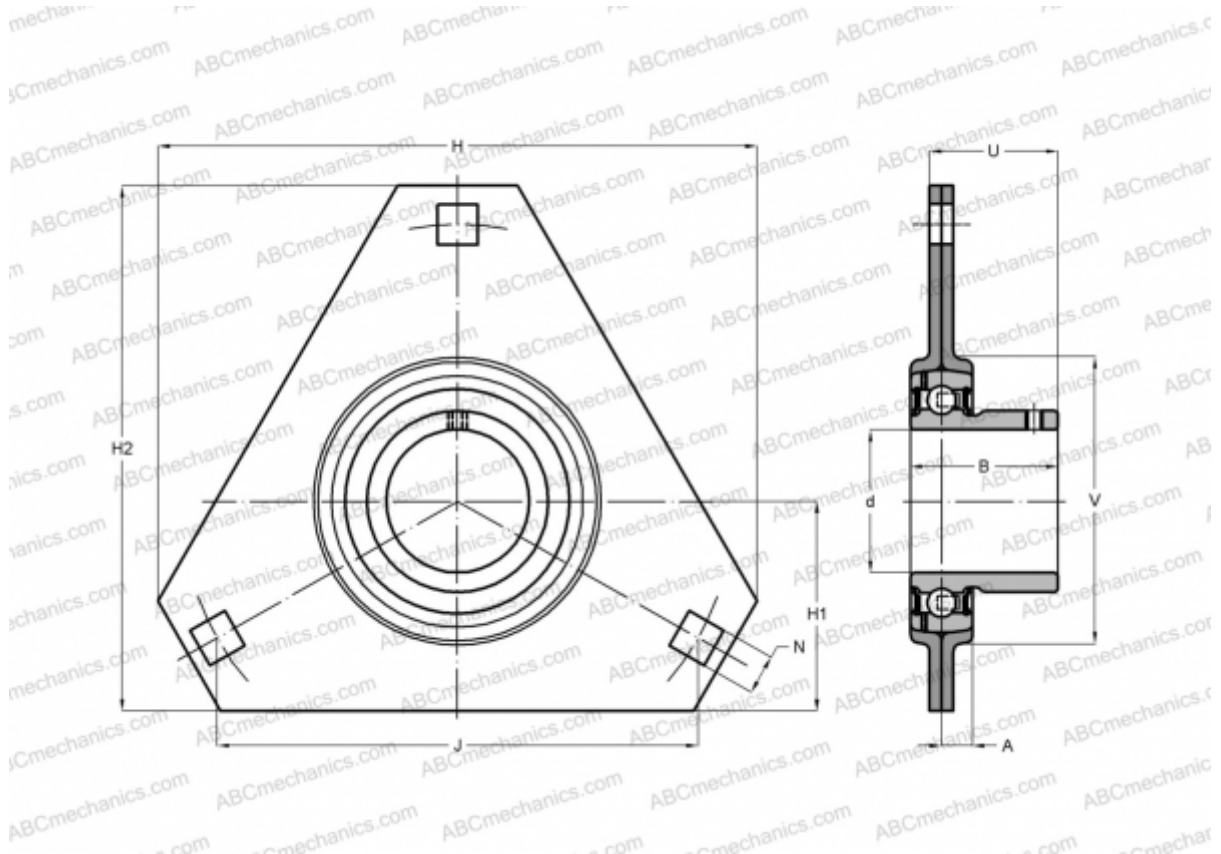

### Technical specification

#### DIMENSIONS, MM

d	15,000
D	40,000
B	22,000
H	81,000
A	7,000
J	63,500
H1	29,000
N	7,000
V	49,000

**WEIGHT, KG** 0,200

Bearing	B 2
Housing	PFT 3

#### MANUFACTURER

[ASAHI](#)

#### INTERCHANGE

ABC

[BPFT 2](#)