

ESPFE205 SNR

Ball bearing units

TYPE: Housing units, Take-up housing units, Sheet steel housing, Radial insert ball bearing with eccentric locking collar, With inner ring extended at one side

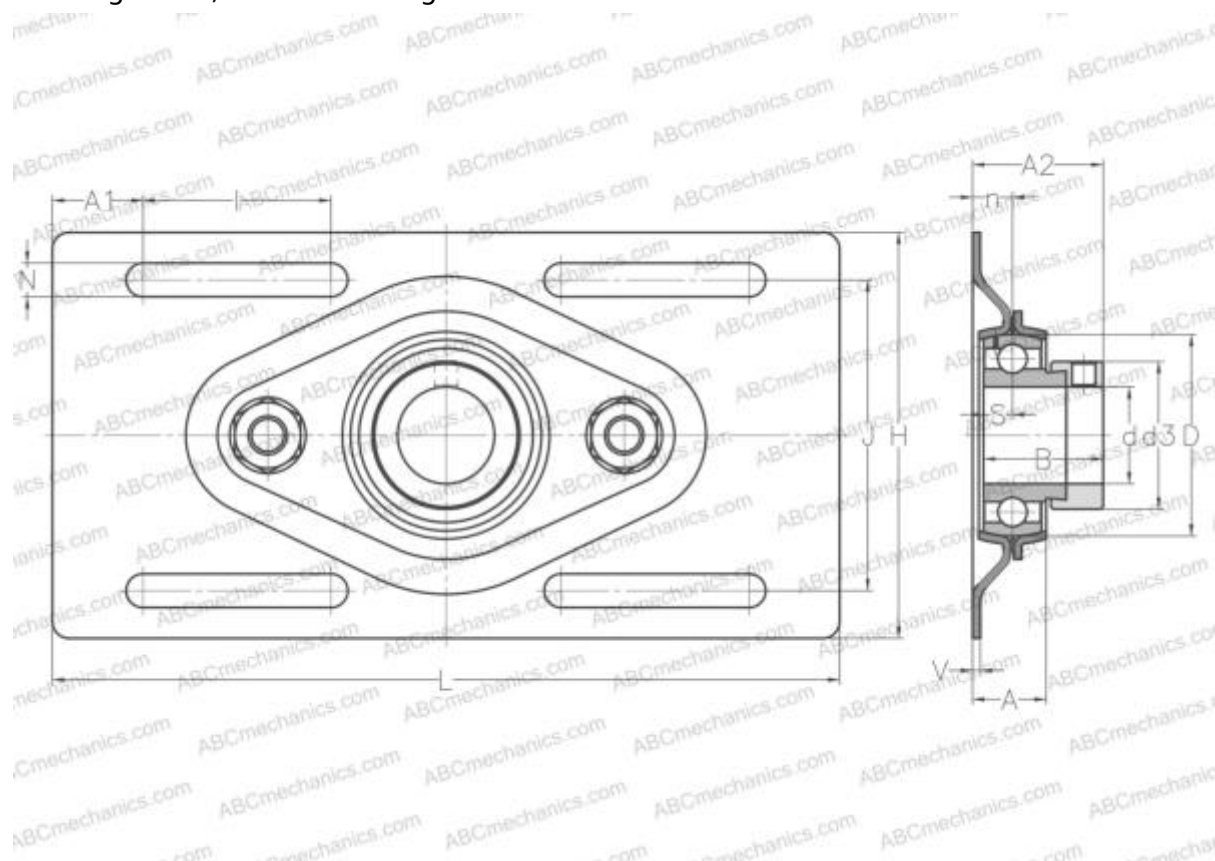

Technical specification

DIMENSIONS, MM

d	25,000
D	52,000
B	30,900
L	203,200
H	104,800
A	19,000
J	80,200
A1	23,400
A2	33,700
N	8,700
S	7,500
d3	38,100
V	2,000
I	48,500
n	10,300

WEIGHT, KG

	0,600
Bearing	ES205
Housing	PFE205

MANUFACTURER

[SNR](#)

INTERCHANGE

ABC	ESPFE205
INA	MSTU25

CALCULATION DATA

Basic dynamic load rating, C	14,000 kN
Basic static load rating, Co	7,880 kN
Operating temperature min	-20 °C
Operating temperature max	110 °C