

ESPFL203 SNR

Ball bearing units

TYPE: Housing units, Two-bolt flanged housing units, Sheet steel housing, Radial insert ball bearing with eccentric locking collar, With inner ring extended at one side

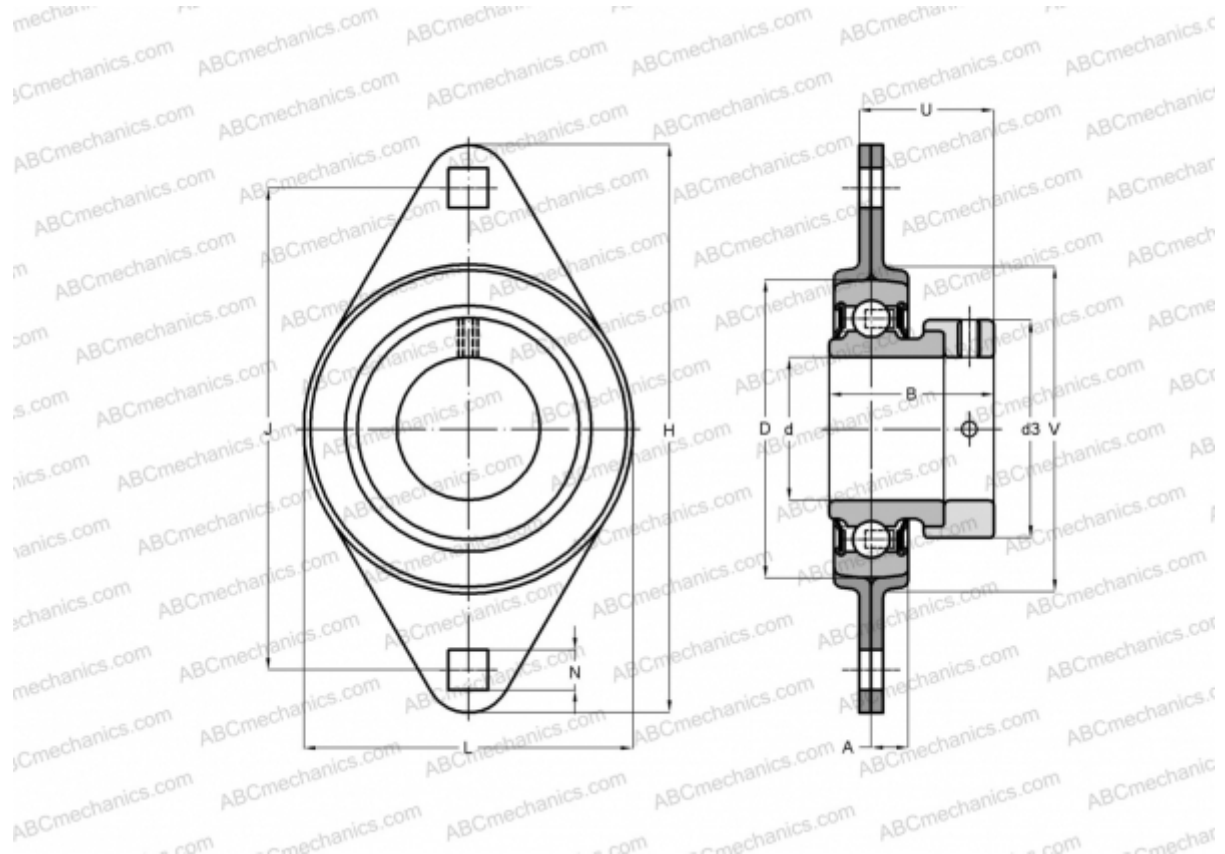

Technical specification

DIMENSIONS, MM

d	17,000
D	40,000
B	28,600
L	58,700
H	81,000
A	6,700
J	63,500
N	7,100
d3	28,600
V	49,000

WEIGHT, KG

Bearing	ES203
Housing	PFL203

MANUFACTURER

[SNR](#)

INTERCHANGE

ABC	ESPFL203
SKF	PFT 17 FM
INA	RAT17

CALCULATION DATA

Basic dynamic load rating, C	9,550 kN
Basic static load rating, Co	4,780 kN
Operating temperature min	-20 °C
Operating temperature max	110 °C