

USPFL202 ABC

Ball bearing units

TYPE: Housing units, Two-bolt flanged housing units, Sheet steel housing, Radial insert ball bearing with grub screws in inner ring, With inner ring extended at one side

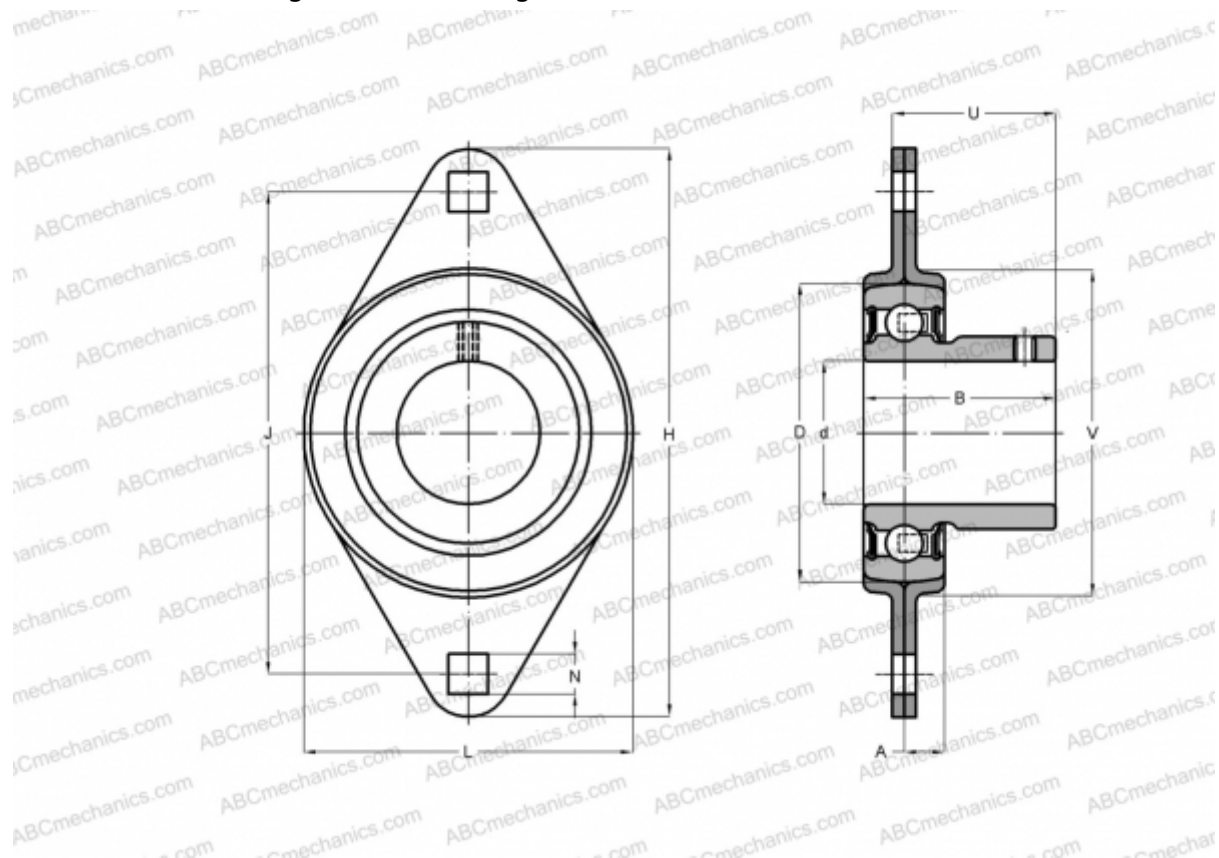

Technical specification

DIMENSIONS, MM

d	15,000
D	40,000
B	22,000
L	58,700
H	81,000
A	6,700
J	63,500
N	7,100
V	49,000

WEIGHT, KG

Bearing	US202
Housing	PFL203

MANUFACTURER

[ABC](#)

INTERCHANGE

ASAHI	BPFL 2
INA	RATY15
SNR	USPFL202
SLB	SBPFL 202
FYH	SBPFL 202
NTN	ASPFL 202