

SUCP201 ABC

Ball bearing units

TYPE: Housing units, Plummer block, Cast iron housing, Radial insert ball bearing with grub screws in inner ring, With inner ring extended on both sides, massive bearing units, stainless steel

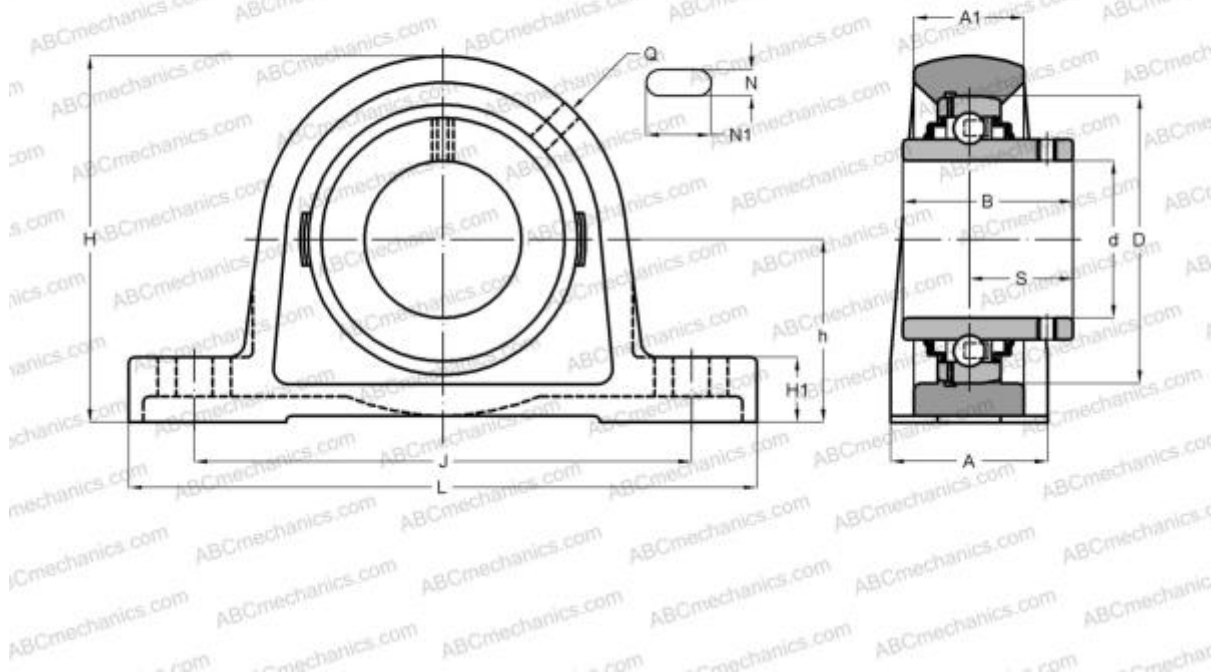

Technical specification

DIMENSIONS, MM

d	12,000
D	47,000
B	31,000
L	126,000
H	65,000
A	38,000
J	95,000
H1	15,000
N	13,000
N1	19,000
S	18,300
h	33,300

WEIGHT, KG

0,830

Bearing	SUC201
Housing	SP204

MANUFACTURER

[ABC](#)

INTERCHANGE

SNR	SUCP201
-----	-------------------------