

## SUCP203 SNR

Ball bearing units

TYPE: Housing units, Plummer block, Cast iron housing, Radial insert ball bearing with grub screws in inner ring, With inner ring extended on both sides, massive bearing units, stainless steel

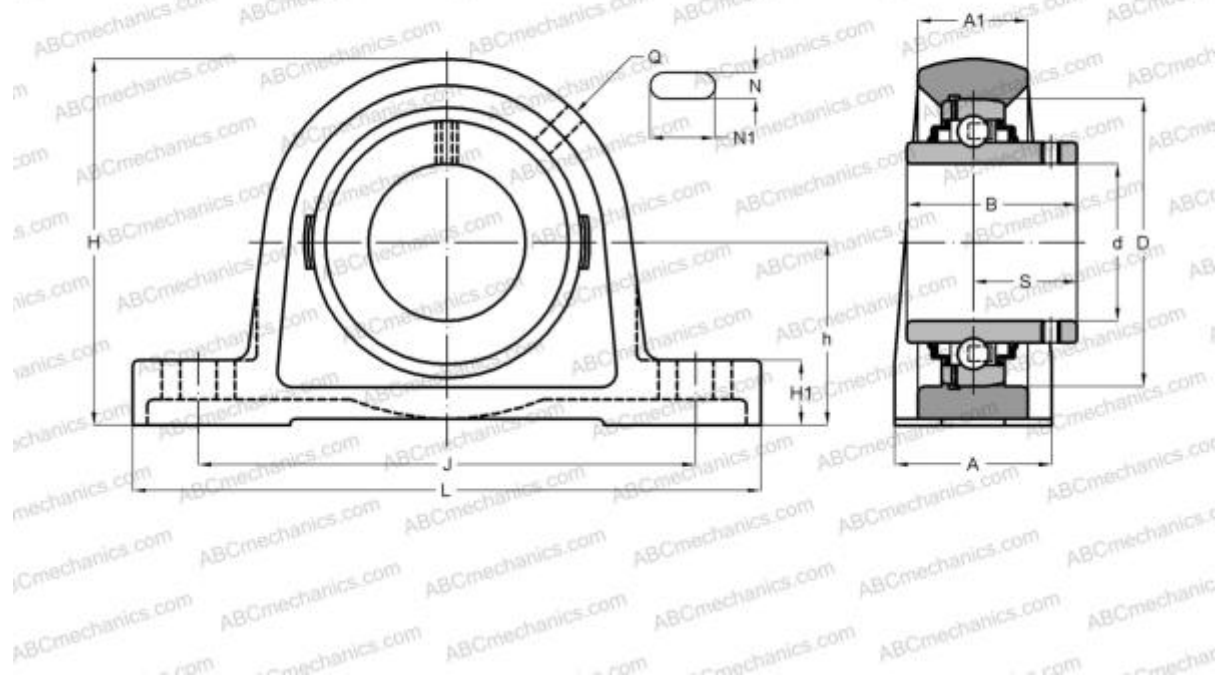

### Technical specification

#### DIMENSIONS, MM

d	17,000
D	47,000
B	31,000
L	126,000
H	65,000
A	38,000
J	95,000
H1	15,000
N	13,000
N1	19,000
S	18,300
h	33,300

**WEIGHT, KG** 0,840

Bearing	SUC203
Housing	SP204

#### MANUFACTURER

[SNR](#)

#### INTERCHANGE

ABC [SUCP203](#)

#### CALCULATION DATA

Operating temperature min	-20 °C
Operating temperature max	120 °C