

SUCPA203 SNR

Ball bearing units

TYPE: Housing units, Plummer block, Narrow cast iron housing, Radial insert ball bearing with grub screws in inner ring, With inner ring extended on both sides, massive bearing units, stainless steel

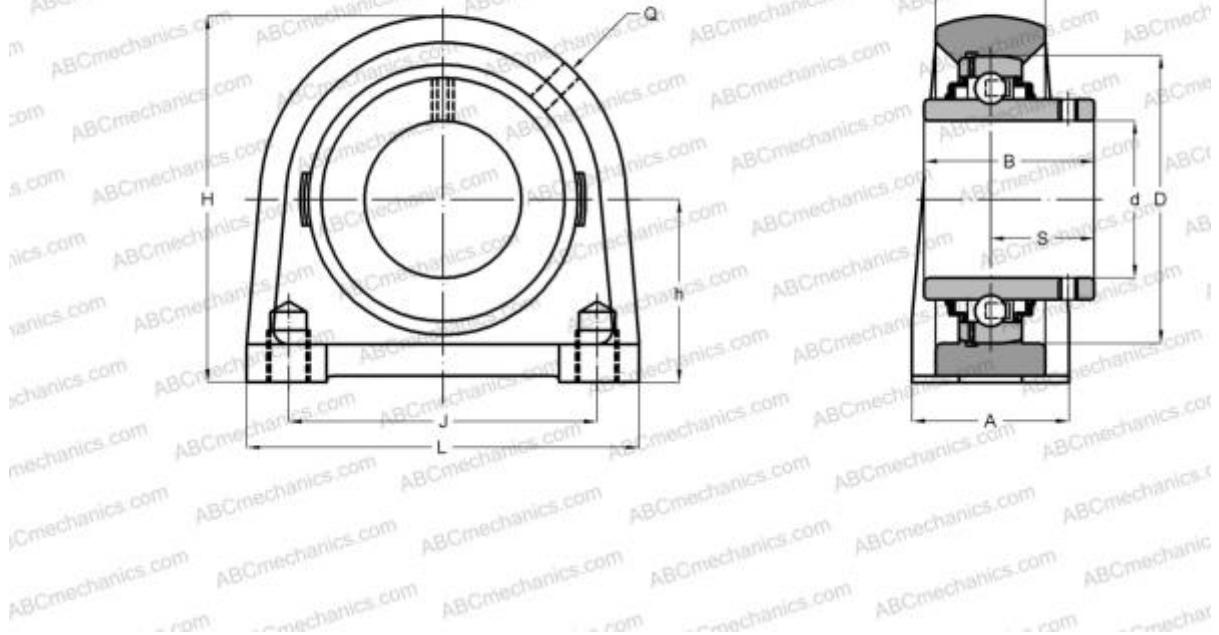

Technical specification

DIMENSIONS, MM

d	17,000
D	47,000
B	31,000
L	73,000
H	65,000
A	38,000
J	50,800
H1	11,000
S	18,300
h	33,300

WEIGHT, KG

0,700

Bearing	SUC203
Housing	SPA204

MANUFACTURER

[SNR](#)

INTERCHANGE

ABC

[SUCPA203](#)

CALCULATION DATA

Operating temperature min	-20 °C
Operating temperature max	120 °C