

SUCPA205-16 ABC

Ball bearing units

TYPE: Housing units, Plummer block, Narrow cast iron housing, Radial insert ball bearing with grub screws in inner ring, With inner ring extended on both sides, massive bearing units, stainless steel, inch size

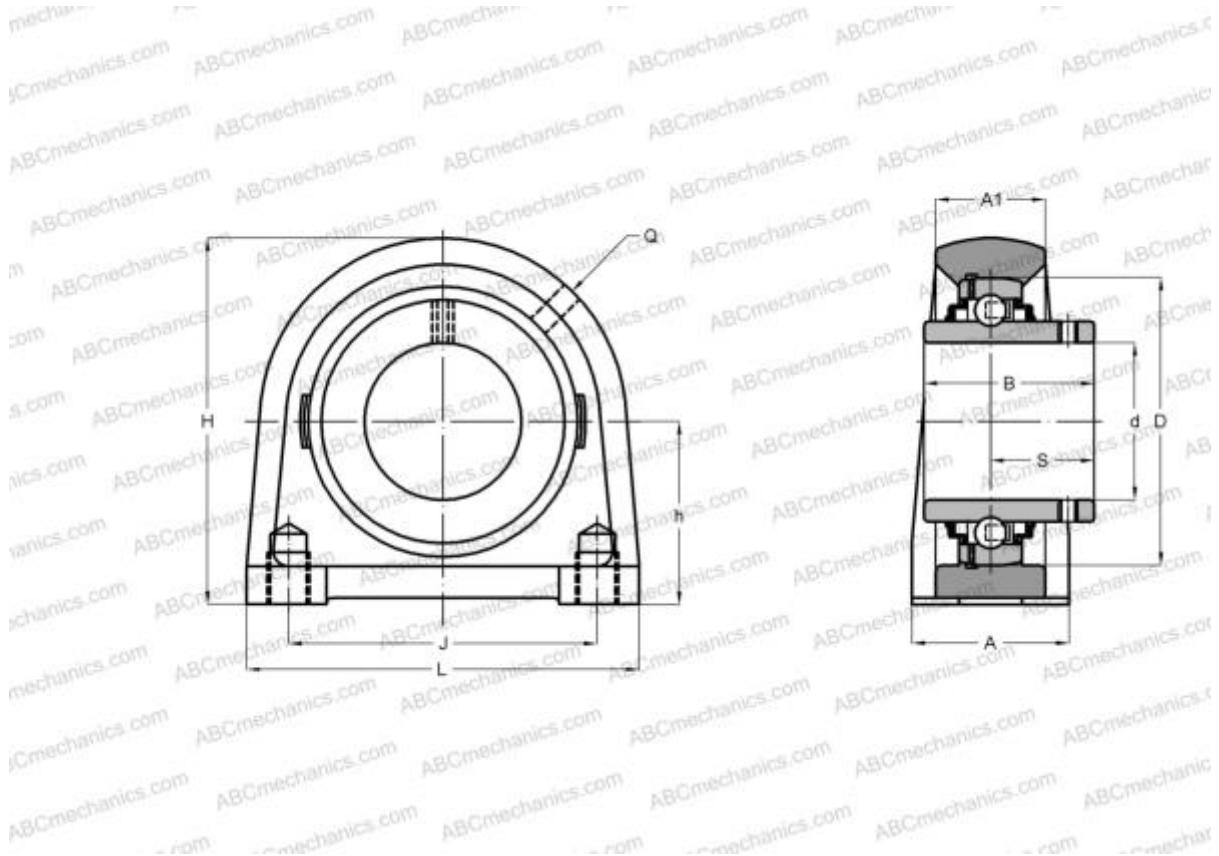

Technical specification

DIMENSIONS, MM

d	25,400
D	52,000
B	34,100
L	76,000
H	71,000
A	38,000
J	50,800
H1	11,000
S	19,800
h	36,500

WEIGHT, KG 0,780

Bearing	SUC205-16
Housing	SPA205

MANUFACTURER

[ABC](#)

INTERCHANGE

SNR

[SUCPA205-16](#)