

SUCPA207-22 SNR

Ball bearing units

TYPE: Housing units, Plummer block, Narrow cast iron housing, Radial insert ball bearing with grub screws in inner ring, With inner ring extended on both sides, massive bearing units, stainless steel, inch size

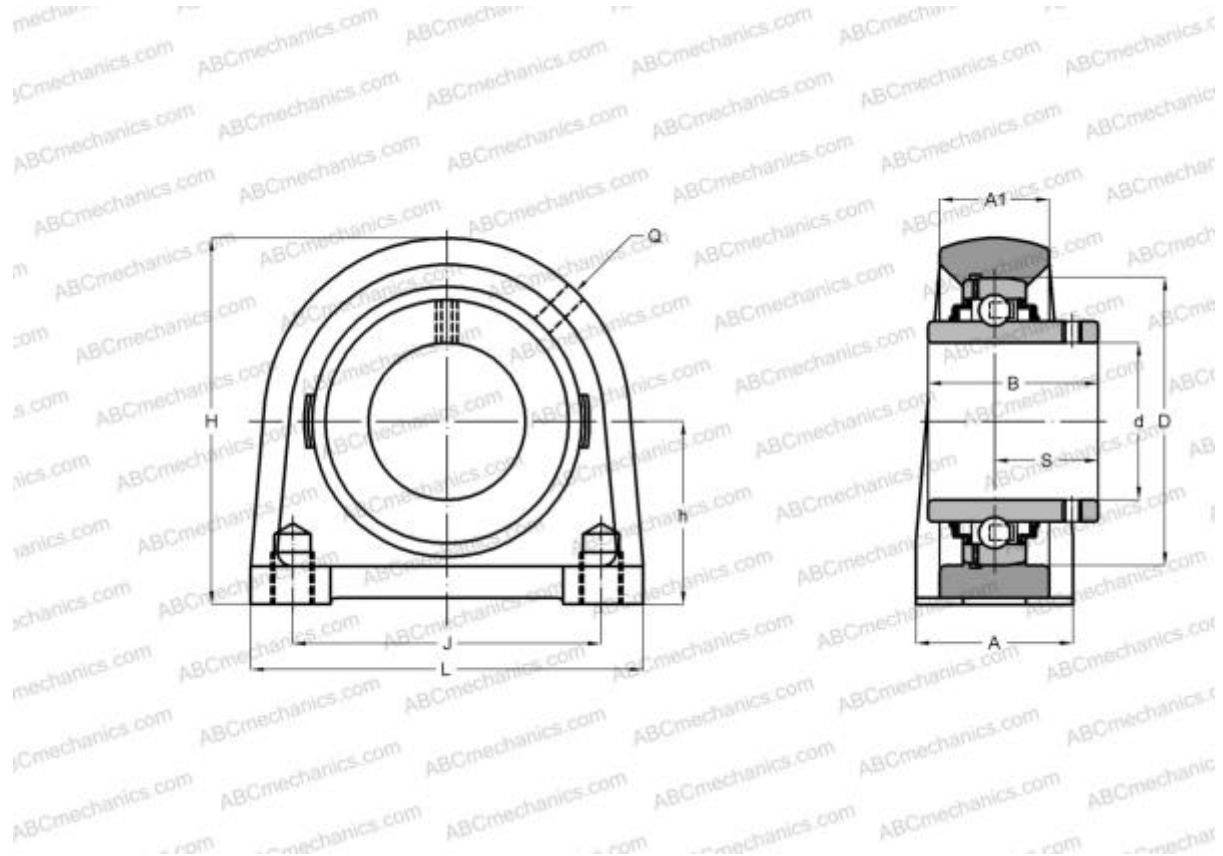

Technical specification

DIMENSIONS, MM

d	34,925
D	72,000
B	42,900
L	108,000
H	95,000
A	48,000
J	82,600
H1	12,000
S	25,400
h	47,600

WEIGHT, KG 1,720

Bearing	SUC207-22
Housing	SPA207

MANUFACTURER

[SNR](#)

INTERCHANGE

ABC

[SUCPA207-22](#)

CALCULATION DATA

Operating temperature min	-20 °C
Operating temperature max	120 °C