

SESFL204 ABC

Ball bearing units

TYPE: Housing units, Two-bolt flanged housing units, Cast iron housing, Radial insert ball bearing with eccentric locking collar, With inner ring extended at one side, wide base, massive bearing units, stainless steel

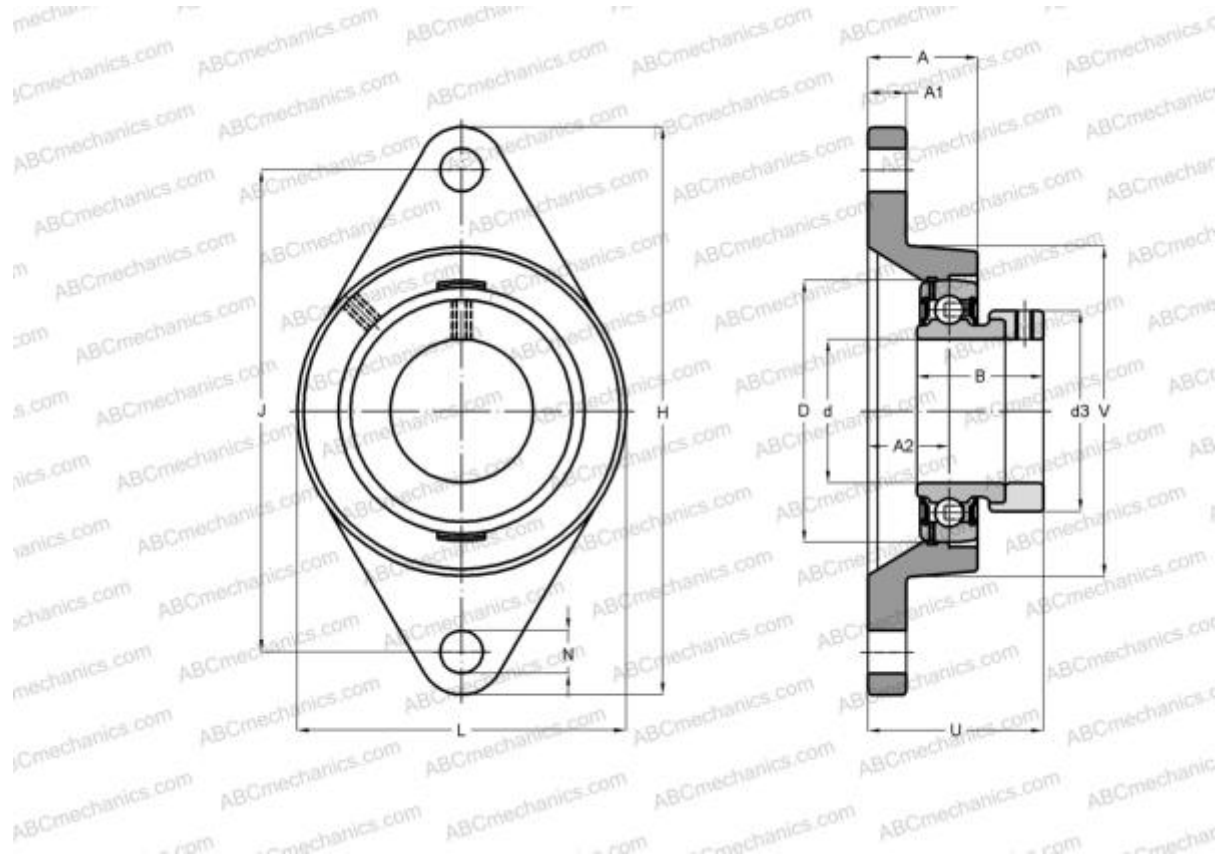

Technical specification

DIMENSIONS, MM

d	20,000
D	47,000
B	31,000
L	60,000
H	112,000
A	25,500
J	90,000
A1	12,000
A2	15,000
N	12,000
d3	33,300
U	39,000

WEIGHT, KG 0,480

Bearing	SES204
Housing	SFL204

MANUFACTURER

[ABC](#)

INTERCHANGE

SNR	SESFL204
-----	--------------------------