

SUCFL202 SNR

Ball bearing units

TYPE: Housing units, Two-bolt flanged housing units, Cast iron housing, Radial insert ball bearing with grub screws in inner ring, With inner ring extended on both sides, massive bearing units, stainless steel

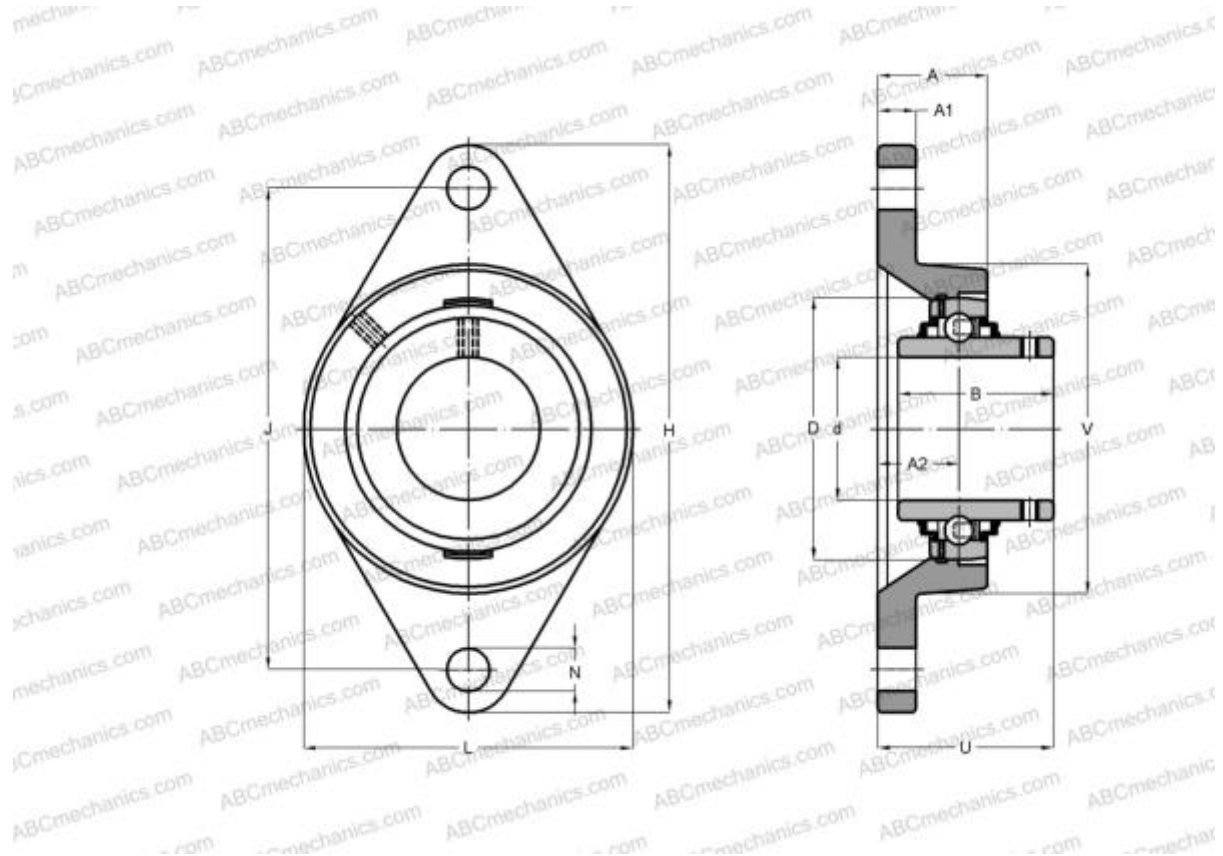

Technical specification

DIMENSIONS, MM

d	15,000
D	47,000
B	31,000
L	60,000
H	112,000
A	25,500
J	90,000
A1	12,000
A2	15,000
N	12,000
U	33,300

WEIGHT, KG 0,510

Bearing SUC202

Housing SFL204

MANUFACTURER [SNR](#)

INTERCHANGE

ABC [SUCFL202](#)

CALCULATION DATA

Operating temperature min -20 °C

Operating temperature max 120 °C