

## SUCFL205 ABC

Ball bearing units

TYPE: Housing units, Two-bolt flanged housing units, Cast iron housing, Radial insert ball bearing with grub screws in inner ring, With inner ring extended on both sides, massive bearing units, stainless steel

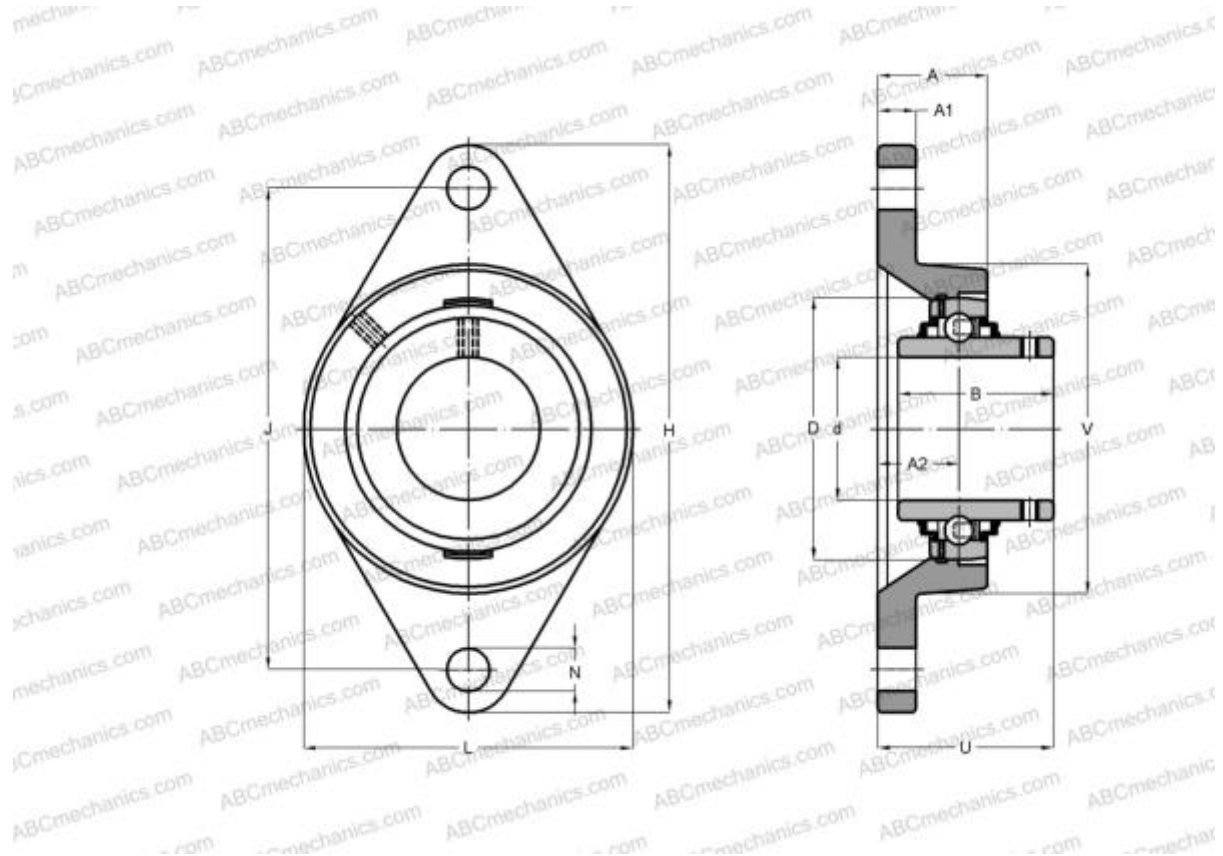

### Technical specification

#### DIMENSIONS, MM

d	25,000
D	52,000
B	34,100
L	68,000
H	125,000
A	27,000
J	99,000
A1	13,000
A2	16,000
N	16,000
U	35,800

**WEIGHT, KG** 0,600

Bearing SUC205

Housing SFL205

**MANUFACTURER** [ABC](#)

#### INTERCHANGE

SNR [SUCFL205](#)