

## SUCFL205-16 SNR

Ball bearing units

TYPE: Housing units, Two-bolt flanged housing units, Cast iron housing, Radial insert ball bearing with grub screws in inner ring, With inner ring extended on both sides, massive bearing units, stainless steel, inch size

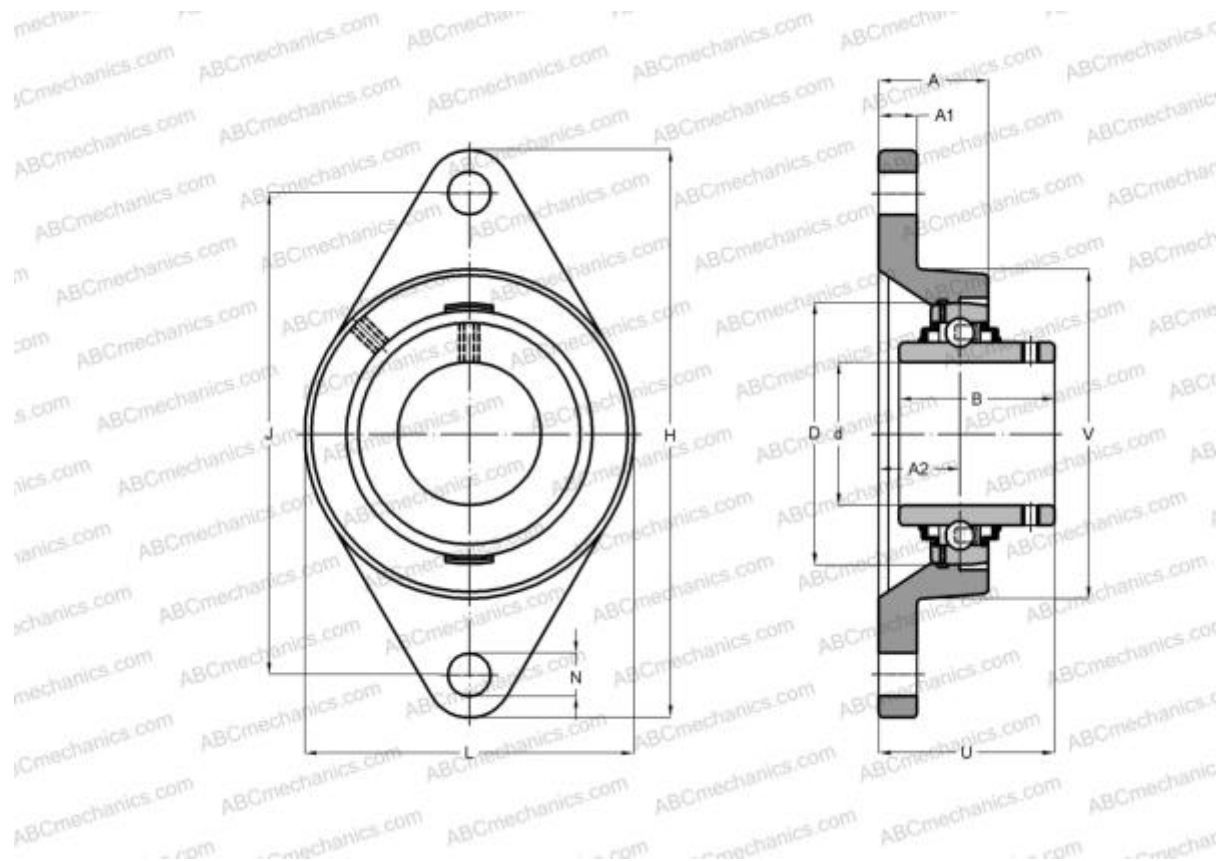

### Technical specification

#### DIMENSIONS, MM

d	25,400
D	52,000
B	34,100
L	68,000
H	125,000
A	27,000
J	99,000
A1	13,000
A2	16,000
N	16,000
U	35,800

#### WEIGHT, KG

0,600

Bearing

SUC205-16

Housing

SFL205

#### MANUFACTURER

[SNR](#)

#### INTERCHANGE

ABC

[SUCFL205-16](#)

#### CALCULATION DATA

Operating temperature min	-20 °C
Operating temperature max	120 °C