

## SESB204 ABC

Ball bearing units

TYPE: Housing units, Three-bolt flange bracket units, Cast iron housing, Radial insert ball bearing with eccentric locking collar, With inner ring extended on both sides, stainless steel

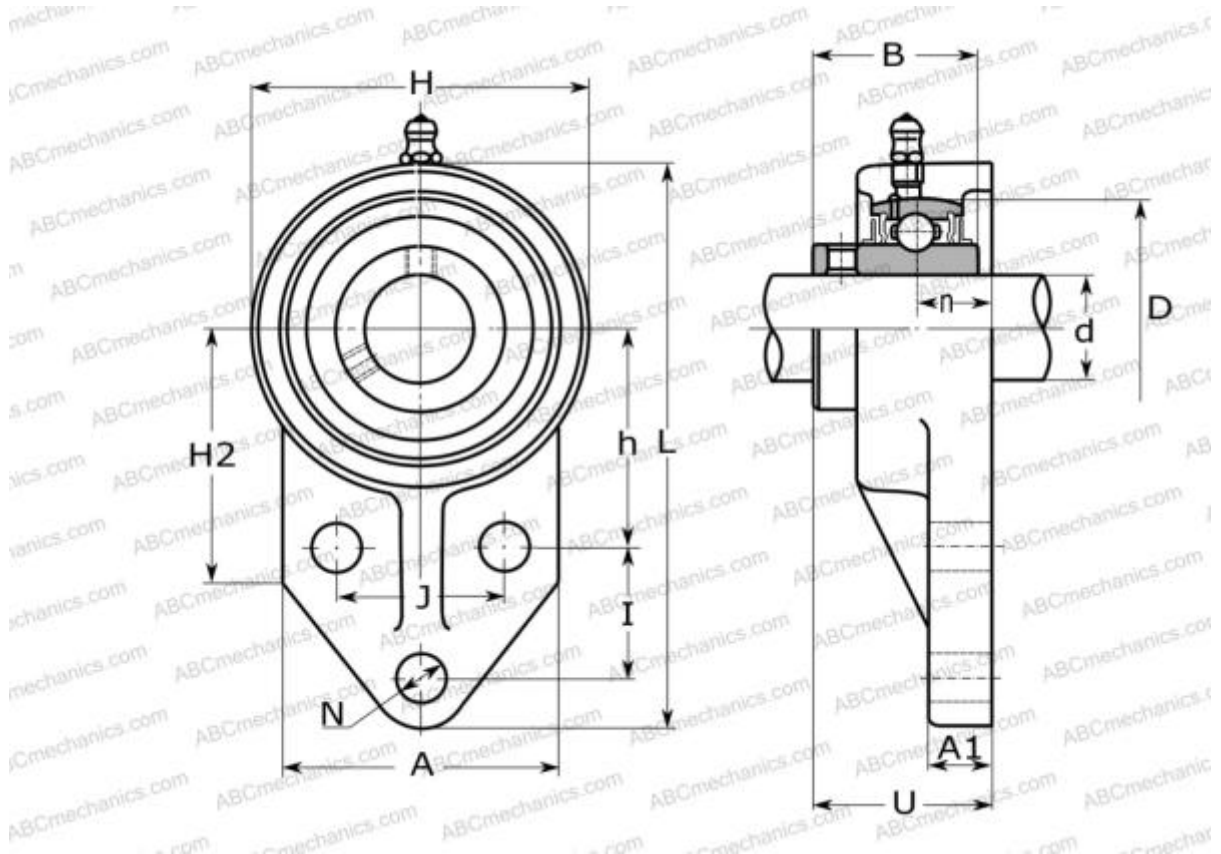

### Technical specification

#### DIMENSIONS, MM

d	20,000
D	47,000
B	31,000
L	106,400
H	60,500
A	60,200
J	38,100
A1	7,900
N	10,000
d3	33,300
U	39,000
I	22,400
h	42,900
n	15,000
Q	M6x1

#### WEIGHT, KG

	0,500
Bearing	SES204
Housing	SFB204

#### MANUFACTURER

[ABC](#)

#### INTERCHANGE

SNR	<a href="#">SESB204</a>
-----	-------------------------