

SUCFB202 ABC

Ball bearing units

TYPE: Housing units, Three-bolt flange bracket units, Cast iron housing, Radial insert ball bearing with grub screws in inner ring, With inner ring extended at one side, stainless steel

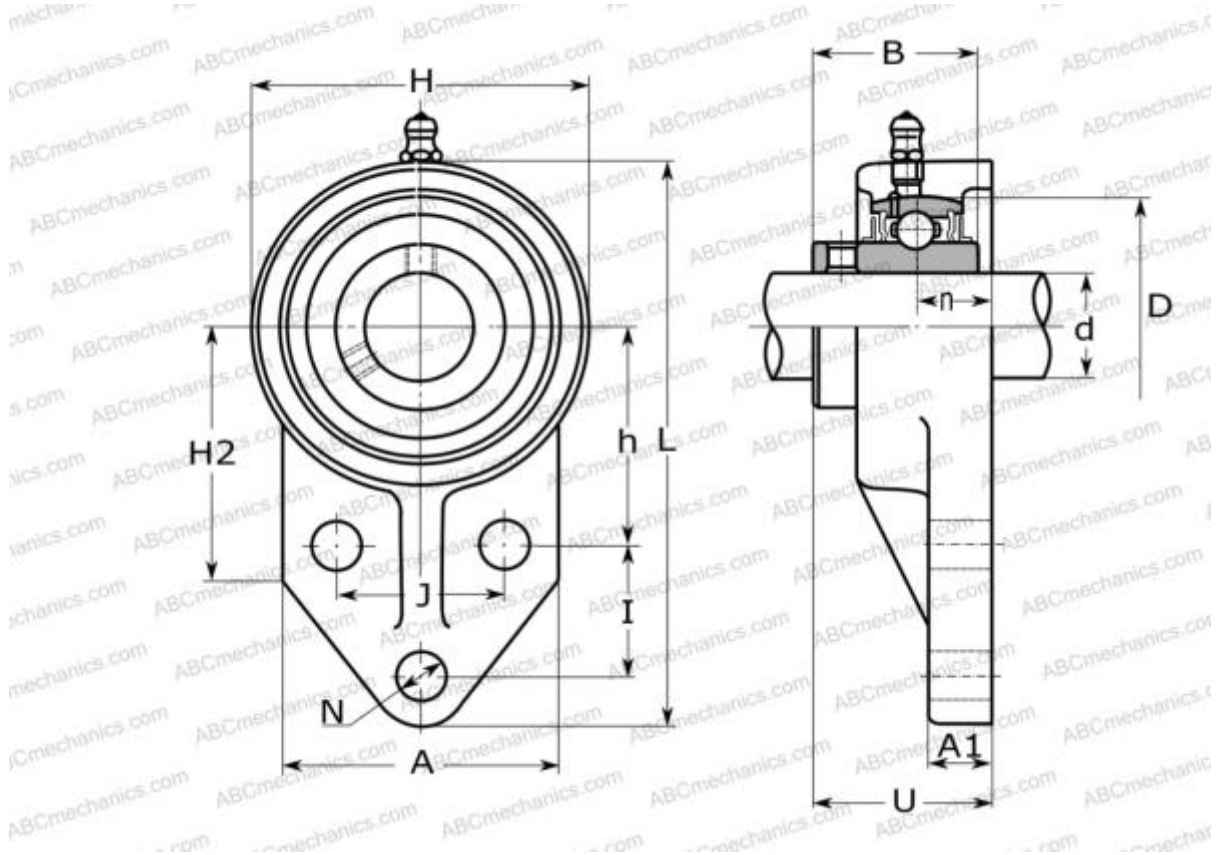

Technical specification

DIMENSIONS, MM

d	15,000
D	47,000
B	31,000
L	106,400
H	60,500
A	60,200
J	38,100
A1	7,900
N	10,000
U	33,300
I	22,400
h	42,900
n	15,000
Q	M6x1

WEIGHT, KG

	0,500
Bearing	SUC202
Housing	SFB204

MANUFACTURER

[ABC](#)

INTERCHANGE

SNR	SUCFB202
-----	--------------------------