

SUCFB205 ABC

Ball bearing units

TYPE: Housing units, Three-bolt flange bracket units, Cast iron housing, Radial insert ball bearing with grub screws in inner ring, With inner ring extended at one side, stainless steel

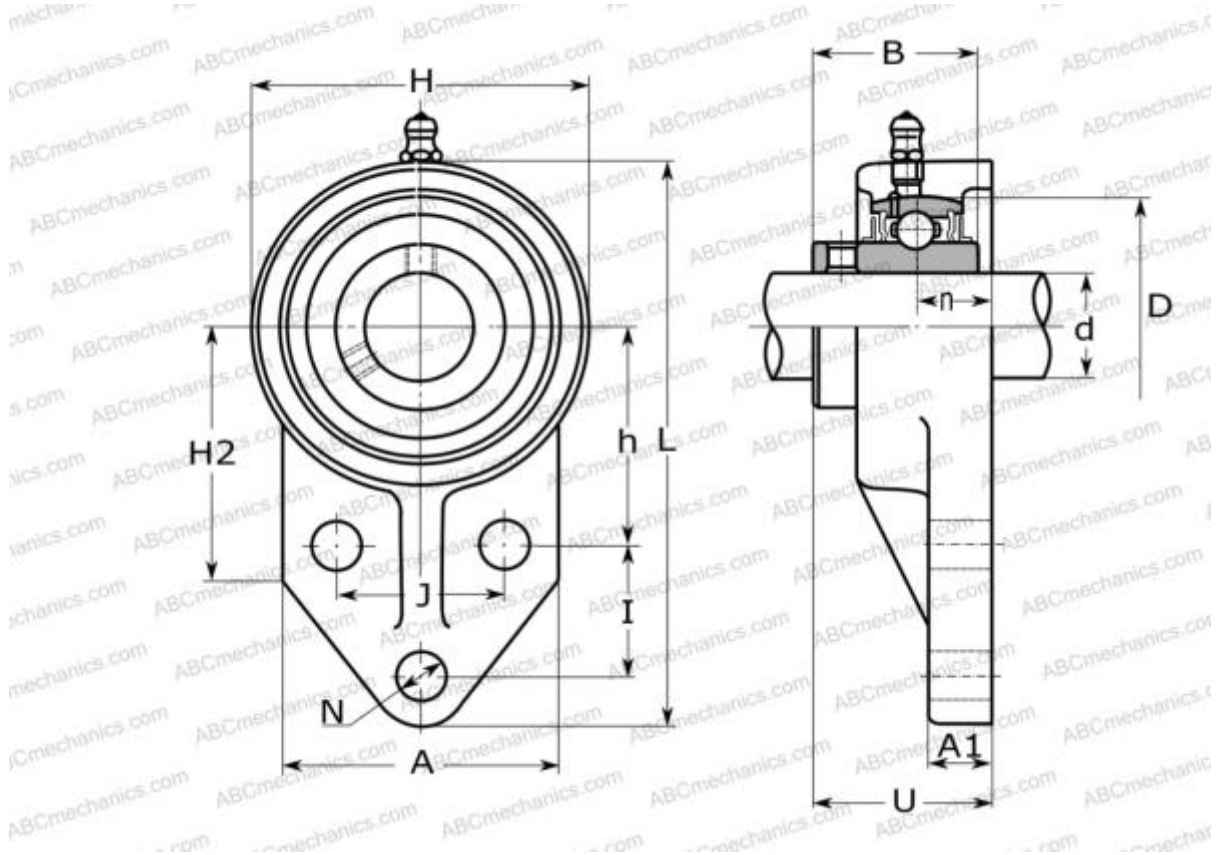

Technical specification

DIMENSIONS, MM

d	25,000
D	52,000
B	34,100
L	119,000
H	67,000
A	63,500
J	41,400
A1	9,700
N	10,000
U	36,000
I	28,700
h	46,000
n	16,000
Q	M6x1

WEIGHT, KG

	0,600
Bearing	SUC205
Housing	SFB205

MANUFACTURER

[ABC](#)

INTERCHANGE

SNR	SUCFB205
-----	--------------------------