

SUCFB205 SNR

Ball bearing units

TYPE: Housing units, Three-bolt flange bracket units, Cast iron housing, Radial insert ball bearing with grub screws in inner ring, With inner ring extended at one side, stainless steel

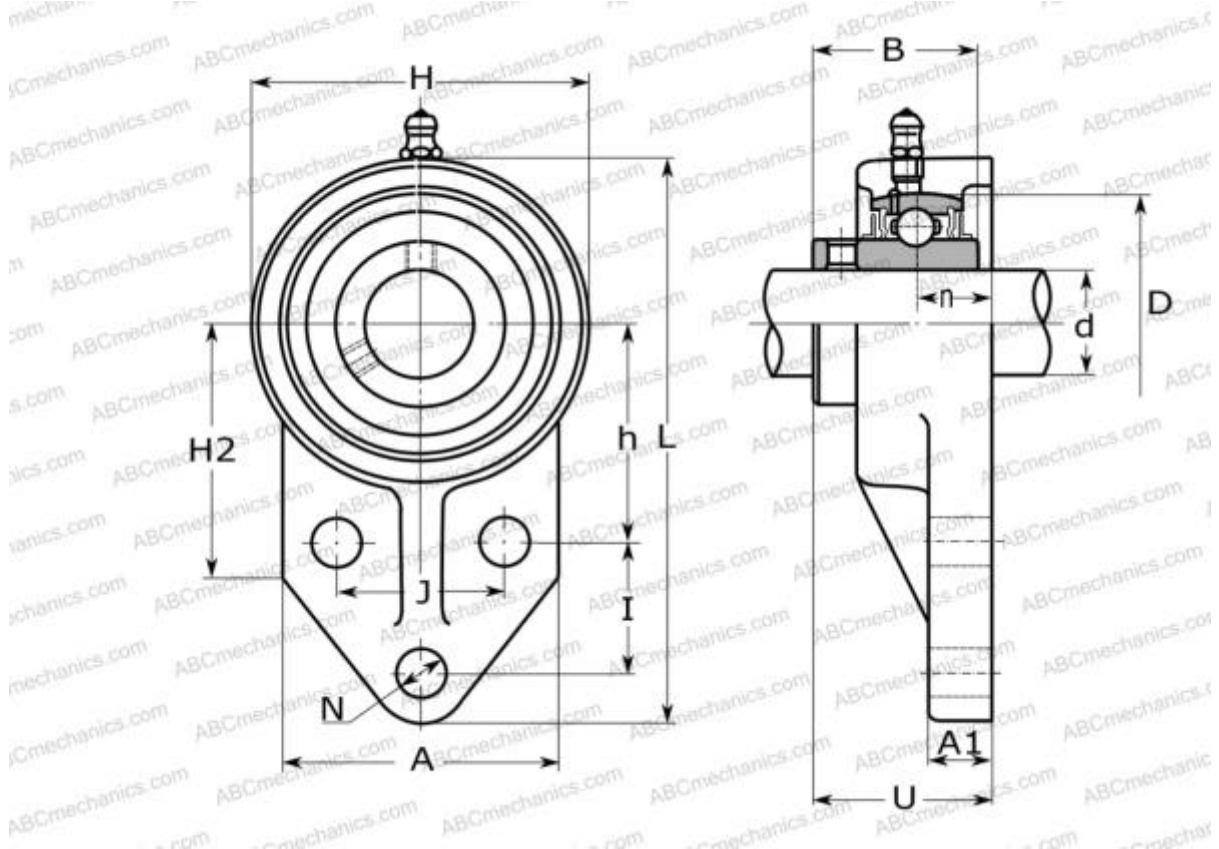

Technical specification

DIMENSIONS, MM

d	25,000
D	52,000
B	34,100
L	119,000
H	67,000
A	63,500
J	41,400
A1	9,700
N	10,000
U	36,000
I	28,700
h	46,000
n	16,000
Q	M6x1

WEIGHT, KG

	0,600
Bearing	SUC205
Housing	SFB205

MANUFACTURER

[SNR](#)

INTERCHANGE

ABC	SUCFB205
-----	--------------------------

CALCULATION DATA

Basic dynamic load rating, C	11,000 kN
Basic static load rating, Co	8,000 kN
Operating temperature min	-20 °C
Operating temperature max	120 °C