

## SESF202 ABC

Ball bearing units

TYPE: Housing units, Four-bolt flanged housing units, Cast iron housing, Radial insert ball bearing with eccentric locking collar, With inner ring extended at one side, stainless steel

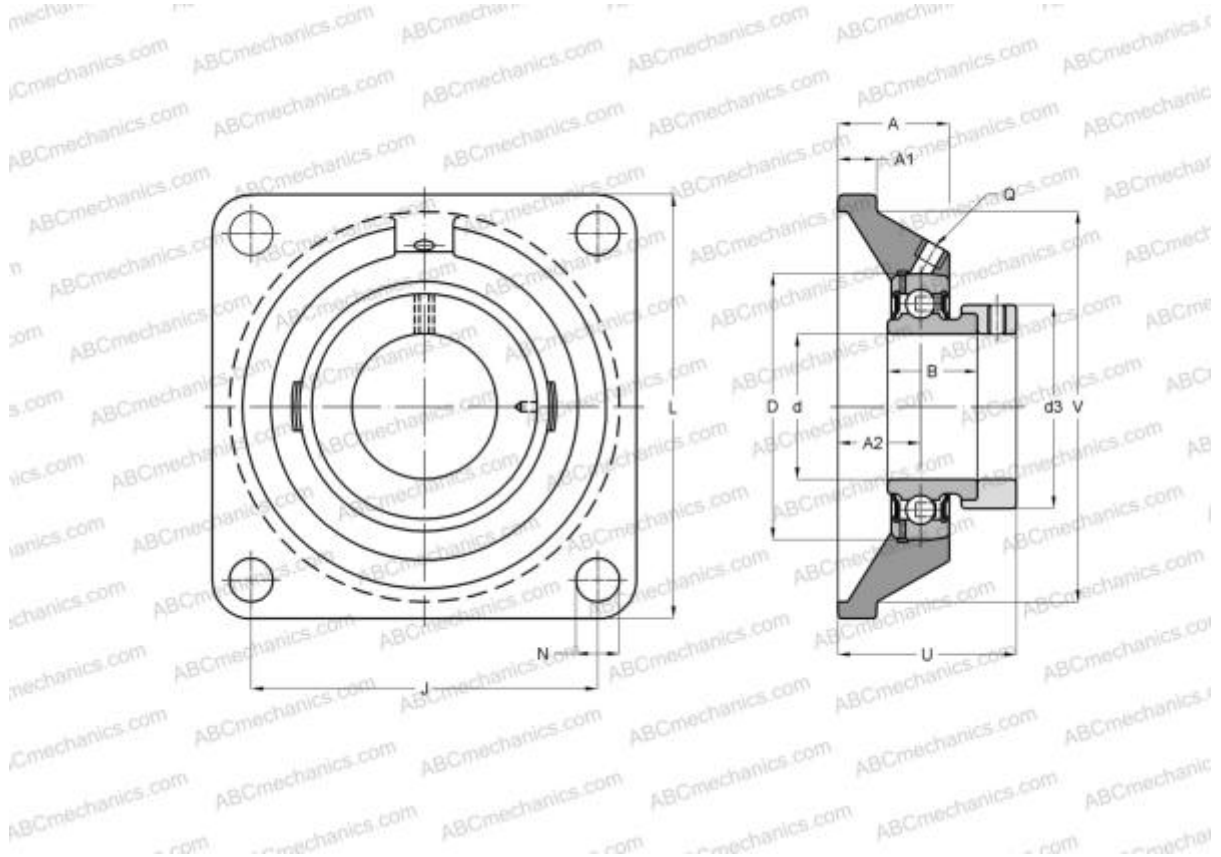

### Technical specification

#### DIMENSIONS, MM

d	15,000
D	40,000
B	28,600
L	86,000
A	25,500
J	64,000
A1	12,000
A2	15,000
N	12,000
d3	28,600
U	37,600

**WEIGHT, KG** 0,570

Bearing SES202

Housing

SF204

**MANUFACTURER**

[ABC](#)

**INTERCHANGE**

SNR

[SESF202](#)