

SESF203 SNR

Ball bearing units

TYPE: Housing units, Four-bolt flanged housing units, Cast iron housing, Radial insert ball bearing with eccentric locking collar, With inner ring extended at one side, stainless steel

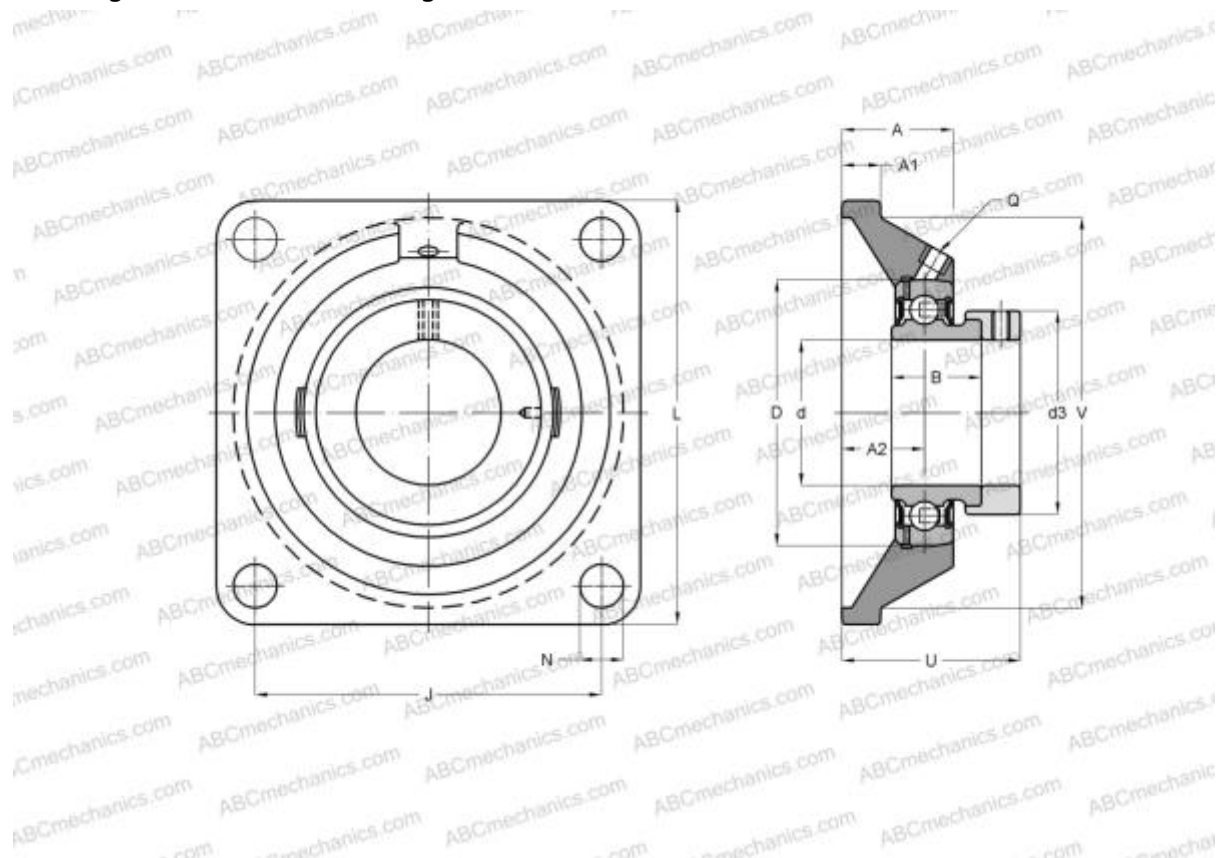

Technical specification

DIMENSIONS, MM

d	17,000
D	40,000
B	28,600
L	86,000
A	25,500
J	64,000
A1	12,000
A2	15,000
N	12,000
d3	28,600
U	37,600

WEIGHT, KG 0,560

Bearing SES203

Housing SF204

MANUFACTURER [SNR](#)

INTERCHANGE

ABC [SESF203](#)

CALCULATION DATA

Operating temperature min	-20 °C
Operating temperature max	120 °C