

SESF204-12 ABC

Ball bearing units

TYPE: Housing units, Four-bolt flanged housing units, Cast iron housing, Radial insert ball bearing with eccentric locking collar, With inner ring extended at one side, stainless steel, inch size

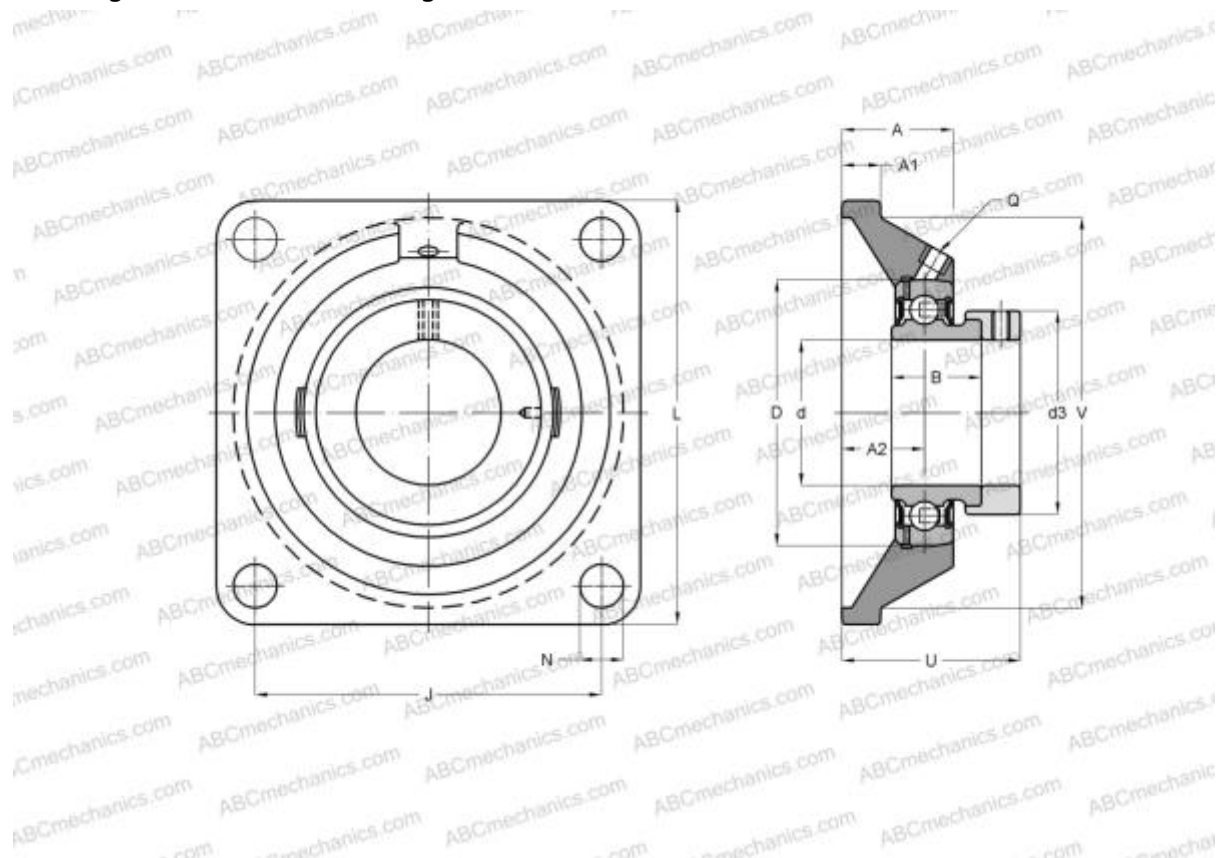

Technical specification

DIMENSIONS, MM

d	19,050
D	47,000
B	31,000
L	86,000
A	25,500
J	64,000
A1	12,000
A2	15,000
N	12,000
d3	33,300
U	39,000

WEIGHT, KG 0,620

Bearing SES204-12

Housing

SF204

MANUFACTURER

[ABC](#)

INTERCHANGE

SNR

[SESF204-12](#)