

SESF205-16 ABC

Ball bearing units

TYPE: Housing units, Four-bolt flanged housing units, Cast iron housing, Radial insert ball bearing with eccentric locking collar, With inner ring extended at one side, stainless steel, inch size

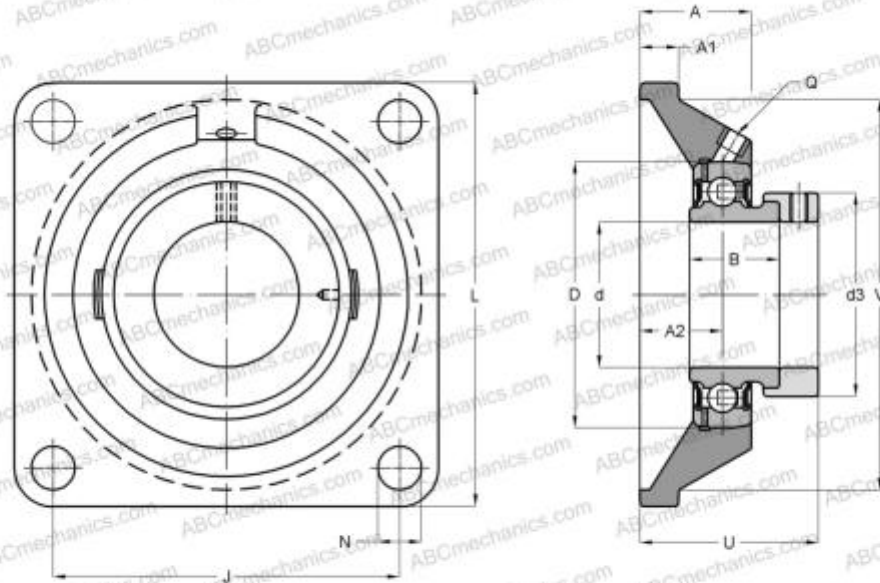

Technical specification

DIMENSIONS, MM

d	25,400
D	52,000
B	31,000
L	95,000
A	27,000
J	70,000
A1	14,000
A2	16,000
N	12,000
d3	38,100
U	39,500

WEIGHT, KG 0,820

Bearing SES205-16

Housing

SF205

MANUFACTURER

[ABC](#)

INTERCHANGE

SNR

[SESF205-16](#)