

SESF206-20 ABC

Ball bearing units

TYPE: Housing units, Four-bolt flanged housing units, Cast iron housing, Radial insert ball bearing with eccentric locking collar, With inner ring extended at one side, stainless steel, inch size

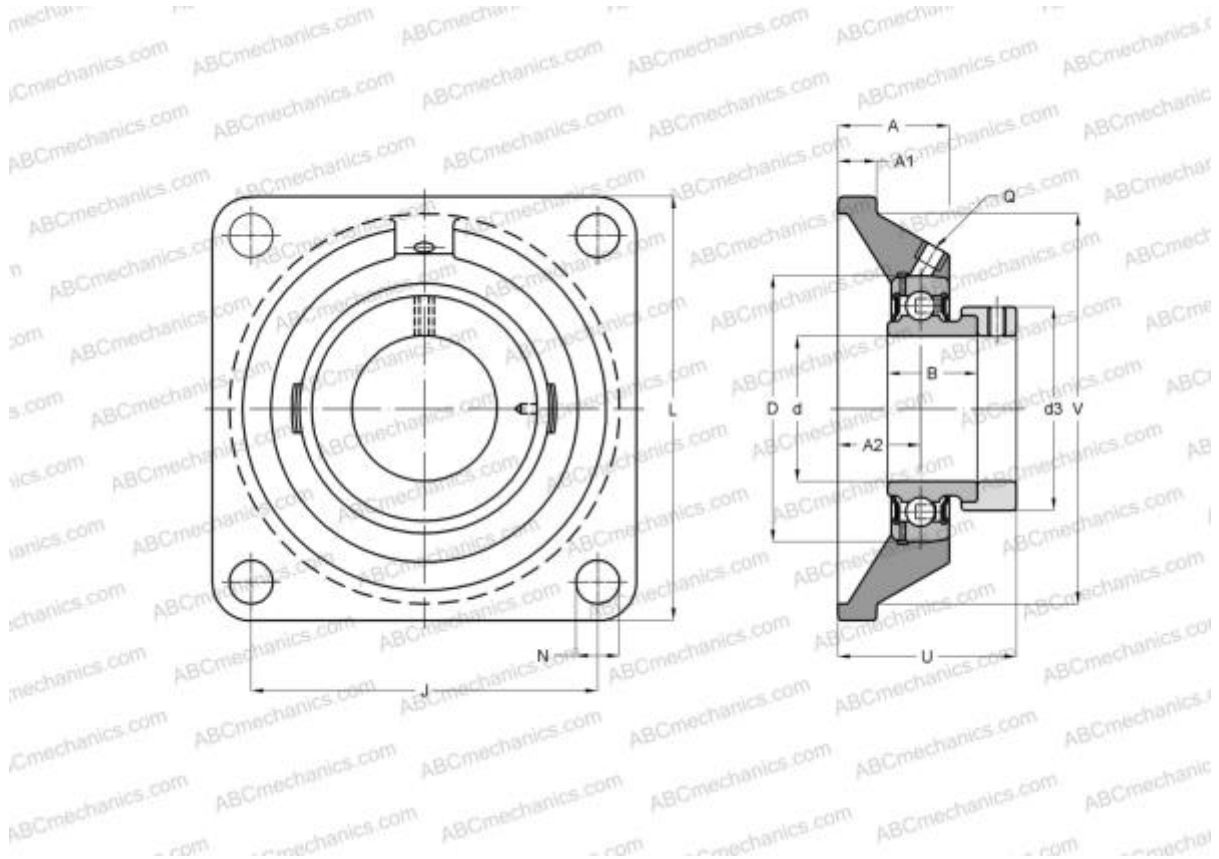

Technical specification

DIMENSIONS, MM

d	31,750
D	62,000
B	35,700
L	108,000
A	30,500
J	83,000
A1	14,000
A2	18,000
N	12,000
d3	44,500
U	45,700

WEIGHT, KG 1,130

Bearing SES206-20

Housing

SF206

MANUFACTURER

[ABC](#)

INTERCHANGE

SNR

[SESF206-20](#)