

SESF207-22 ABC

Ball bearing units

TYPE: Housing units, Four-bolt flanged housing units, Cast iron housing, Radial insert ball bearing with eccentric locking collar, With inner ring extended at one side, stainless steel, inch size

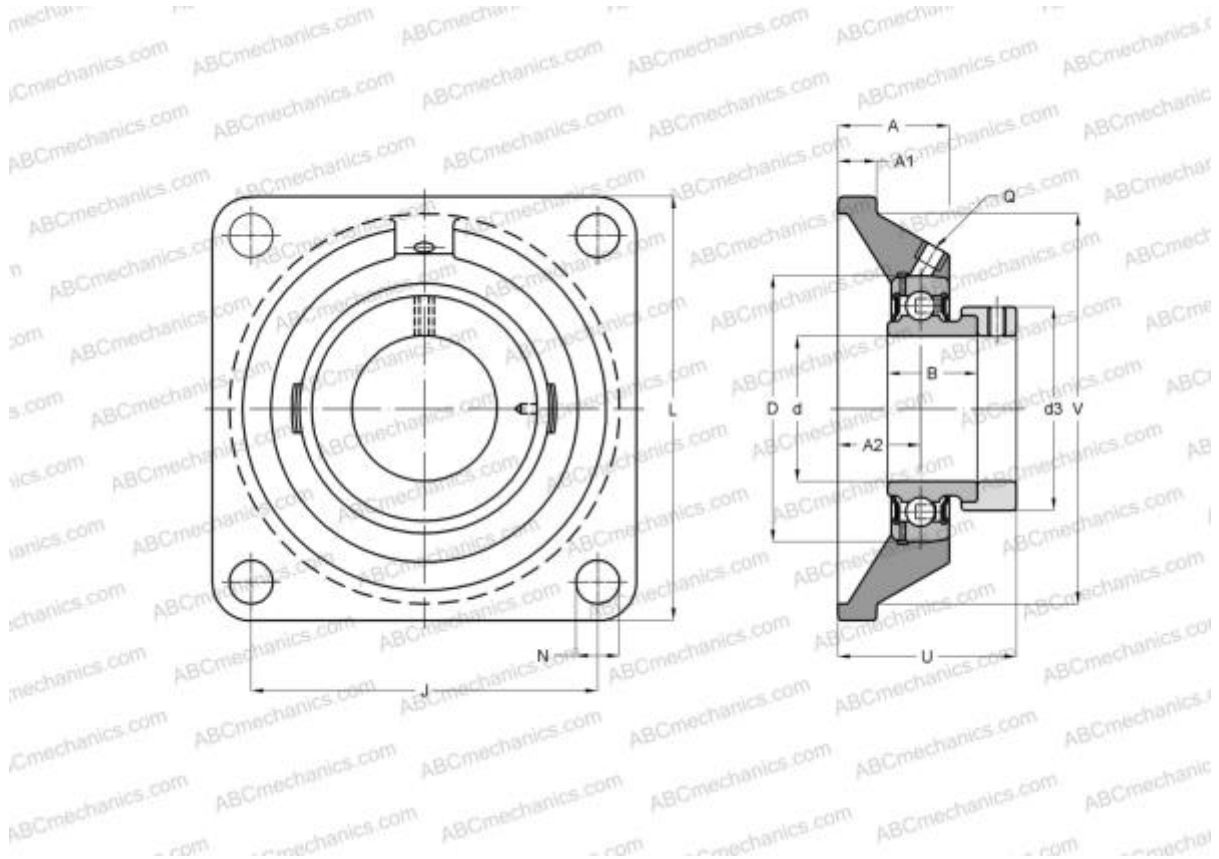

Technical specification

DIMENSIONS, MM

d	34,925
D	72,000
B	38,900
L	116,000
A	33,500
J	92,000
A1	14,500
A2	19,000
N	14,000
d3	55,600
U	49,400

WEIGHT, KG 1,440

Bearing SES207-22

Housing

SF207

MANUFACTURER

[ABC](#)

INTERCHANGE

SNR

[SESF207-22](#)