

SUCF203 ABC

Ball bearing units

TYPE: Housing units, Four-bolt flanged housing units, Cast iron housing, Radial insert ball bearing with grub screws in inner ring, With inner ring extended on both sides, stainless steel

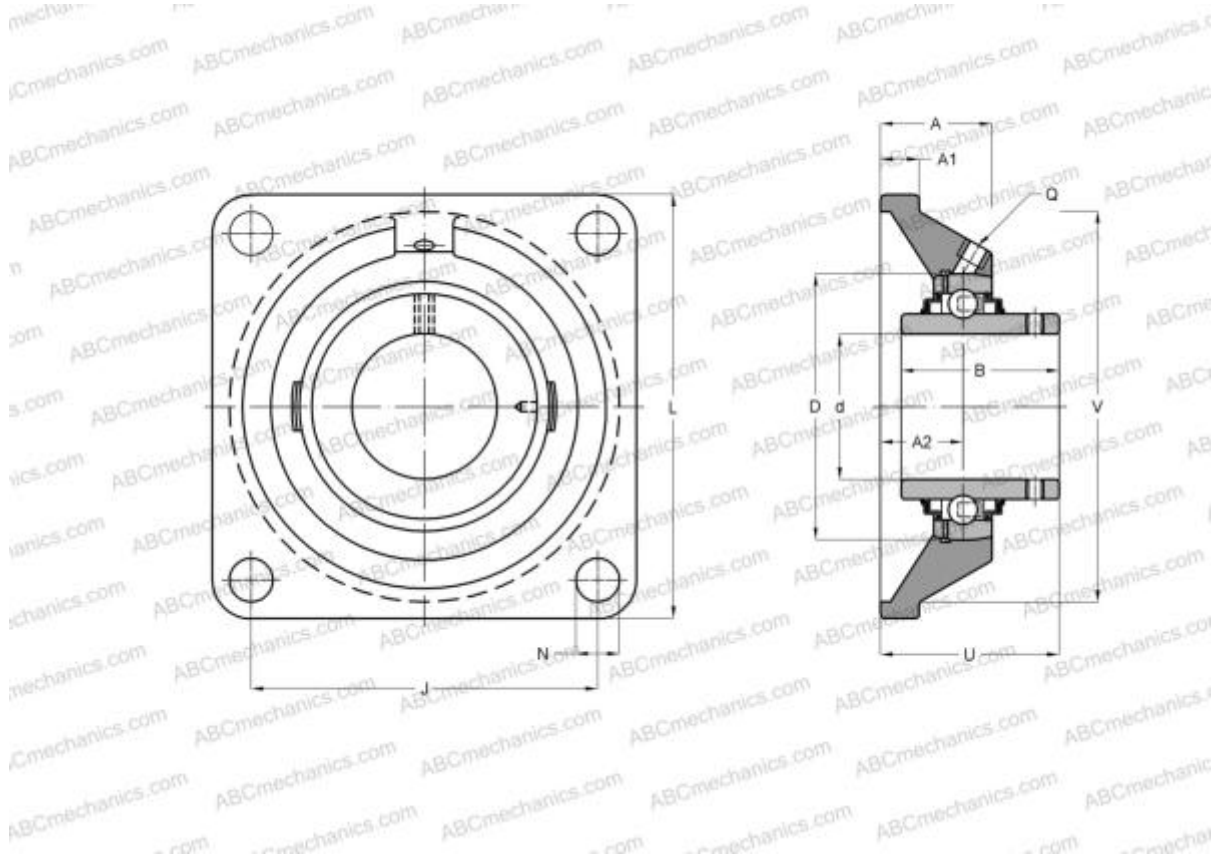

Technical specification

DIMENSIONS, MM

d	17,000
D	47,000
B	31,000
L	86,000
A	25,500
J	64,000
A1	12,000
A2	15,000
N	12,000
U	33,300

WEIGHT, KG

0,630

Bearing	SUC203
Housing	SF204

MANUFACTURER

[ABC](#)

INTERCHANGE

SNR

[SUCF203](#)