

SUCF205 ABC

Ball bearing units

TYPE: Housing units, Four-bolt flanged housing units, Cast iron housing, Radial insert ball bearing with grub screws in inner ring, With inner ring extended on both sides, stainless steel

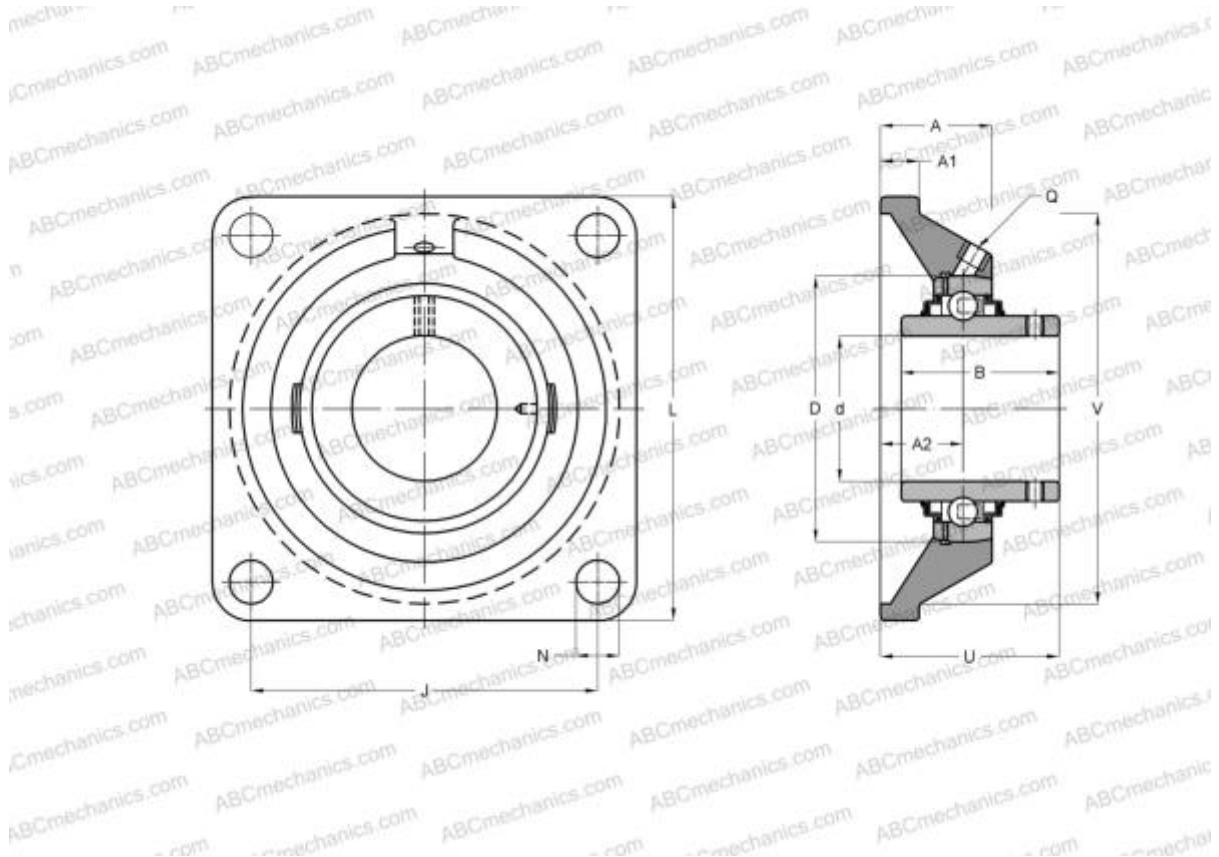

Technical specification

DIMENSIONS, MM

d	25,000
D	52,000
B	34,100
L	95,000
A	27,000
J	70,000
A1	14,000
A2	16,000
N	12,000
U	35,800

WEIGHT, KG

0,820

Bearing	SUC205
Housing	SF205

MANUFACTURER

[ABC](#)

INTERCHANGE

SNR

[SUCF205](#)