

SUCF204-12 ABC

Ball bearing units

TYPE: Housing units, Four-bolt flanged housing units, Cast iron housing, Radial insert ball bearing with grub screws in inner ring, With inner ring extended on both sides, stainless steel, inch size

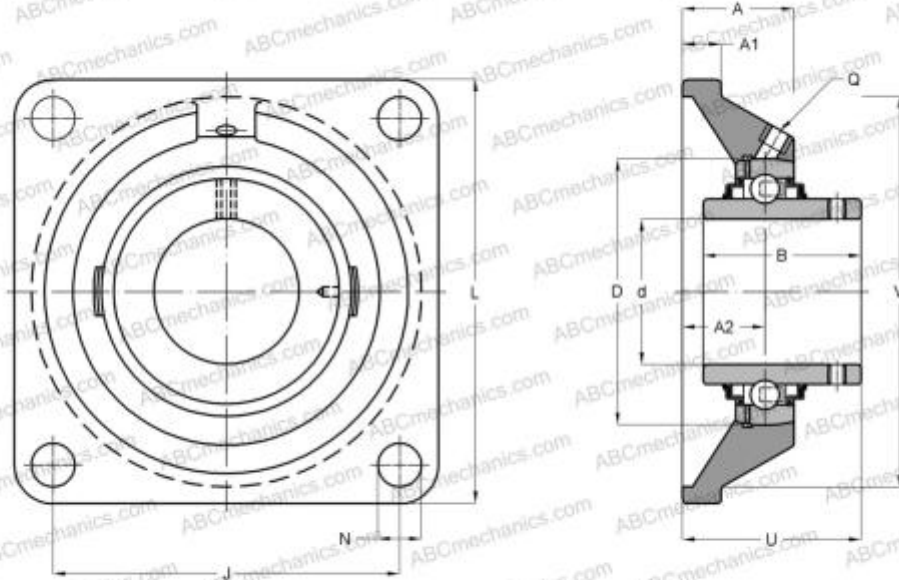

Technical specification

DIMENSIONS, MM

d	19,050
D	47,000
B	31,000
L	86,000
A	25,500
J	64,000
A1	12,000
A2	15,000
N	12,000
U	33,300

WEIGHT, KG

0,610

Bearing	SUC204-12
Housing	SF204

MANUFACTURER

[ABC](#)

INTERCHANGE

SNR

[SUCF204-12](#)