

SUCF205-16 ABC

Ball bearing units

TYPE: Housing units, Four-bolt flanged housing units, Cast iron housing, Radial insert ball bearing with grub screws in inner ring, With inner ring extended on both sides, stainless steel, inch size

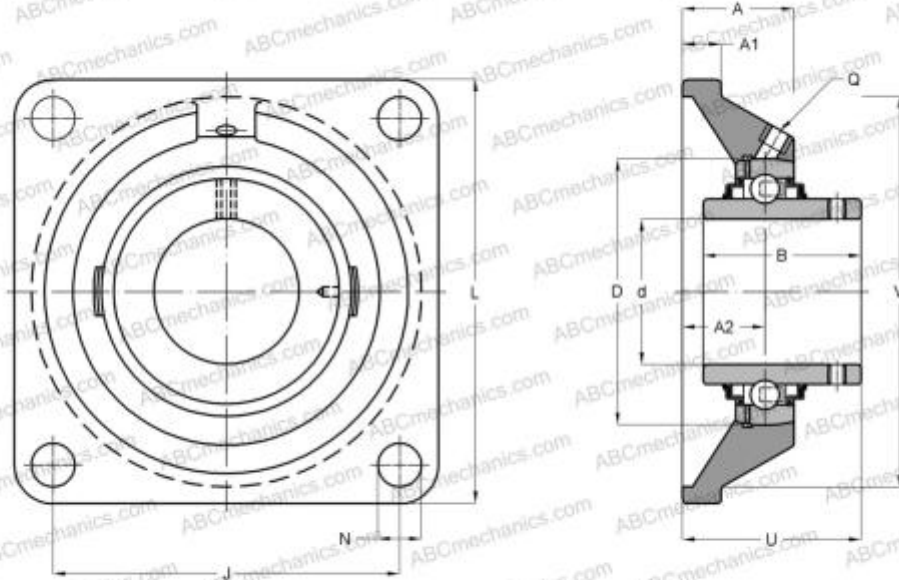

Technical specification

DIMENSIONS, MM

d	25,400
D	52,000
B	34,100
L	95,000
A	27,000
J	70,000
A1	14,000
A2	16,000
N	12,000
U	35,800

WEIGHT, KG

0,820

Bearing	SUC205-16
Housing	SF205

MANUFACTURER

[ABC](#)

INTERCHANGE

SNR

[SUCF205-16](#)