

SUCF206-20 ABC

Ball bearing units

TYPE: Housing units, Four-bolt flanged housing units, Cast iron housing, Radial insert ball bearing with grub screws in inner ring, With inner ring extended on both sides, stainless steel, inch size

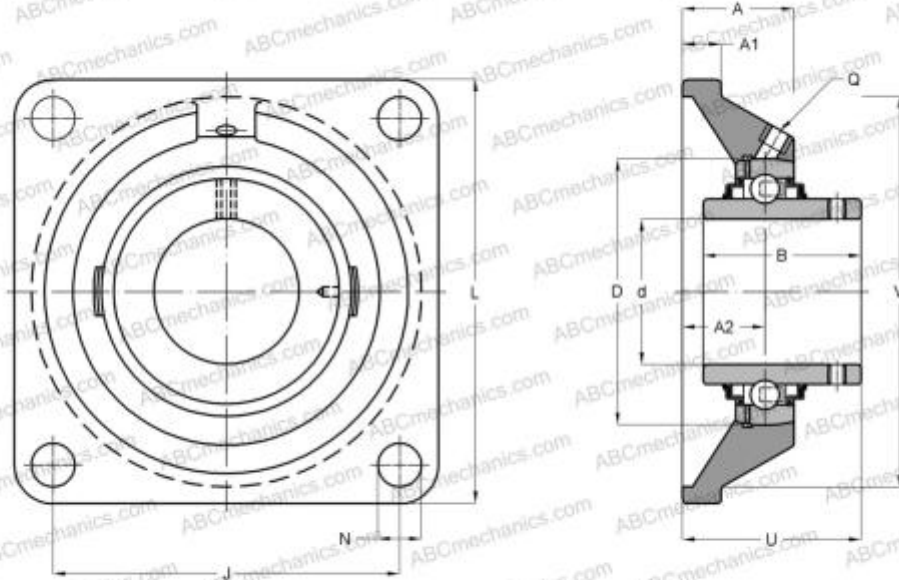

Technical specification

DIMENSIONS, MM

d	31,750
D	62,000
B	38,100
L	108,000
A	30,500
J	83,000
A1	14,000
A2	18,000
N	12,000
U	40,200

WEIGHT, KG

1,130

Bearing	SUC206-20
Housing	SF206

MANUFACTURER

[ABC](#)

INTERCHANGE

SNR

[SUCF206-20](#)