

## SUCF206-20 SNR

Ball bearing units

TYPE: Housing units, Four-bolt flanged housing units, Cast iron housing, Radial insert ball bearing with grub screws in inner ring, With inner ring extended on both sides, stainless steel, inch size

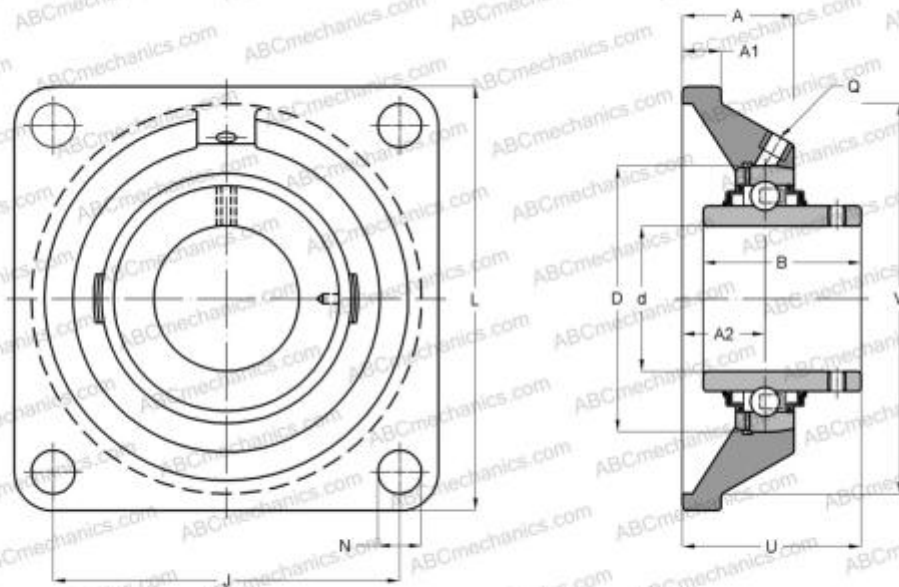

### Technical specification

#### DIMENSIONS, MM

d	31,750
D	62,000
B	38,100
L	108,000
A	30,500
J	83,000
A1	14,000
A2	18,000
N	12,000
U	40,200

#### WEIGHT, KG

1,130

Bearing	SUC206-20
Housing	SF206

#### MANUFACTURER

[SNR](#)

#### INTERCHANGE

ABC

[SUCF206-20](#)

#### CALCULATION DATA

Operating temperature min	-20 °C
Operating temperature max	120 °C