

SUCF207-22 ABC

Ball bearing units

TYPE: Housing units, Four-bolt flanged housing units, Cast iron housing, Radial insert ball bearing with grub screws in inner ring, With inner ring extended on both sides, stainless steel, inch size

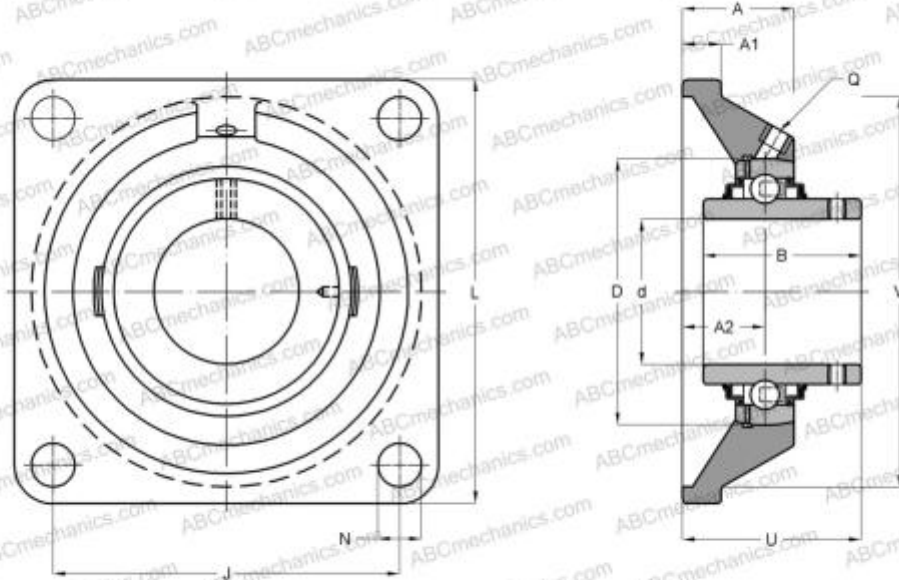

Technical specification

DIMENSIONS, MM

d	34,925
D	72,000
B	42,900
L	116,000
A	33,500
J	92,000
A1	14,500
A2	19,000
N	14,000
U	44,400

WEIGHT, KG

1,410

Bearing	SUC207-22
Housing	SF207

MANUFACTURER

[ABC](#)

INTERCHANGE

SNR

[SUCF207-22](#)