

## SEST202 ABC

Ball bearing units

TYPE: Housing units, Take-up housing units, Cast iron housing, Radial insert ball bearing with eccentric locking collar, With inner ring extended at one side, for tensioning frame, stainless steel

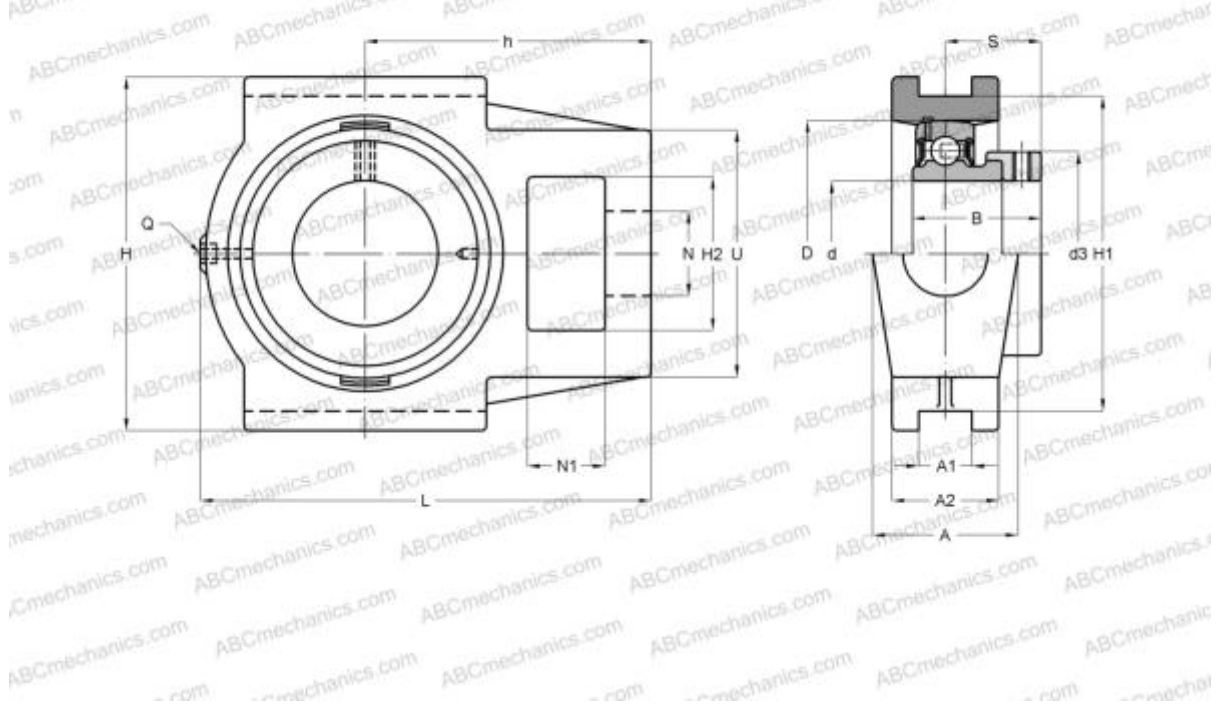

### Technical specification

#### DIMENSIONS, MM

d	15,000
D	40,000
B	28,600
L	94,000
H	89,000
A	32,000
H2	32,000
A1	12,000
A2	21,000
H1	76,000
N	19,000
N1	16,000
S	22,600
d3	28,600
U	51,000

#### DIMENSIONS, MM

h	61,000
---	--------

#### WEIGHT, KG

	0,760
Bearing	SES202
Housing	ST204

#### MANUFACTURER

[ABC](#)

#### INTERCHANGE

SNR	<a href="#">SEST202</a>
-----	-------------------------