

SEST203 SNR

Ball bearing units

TYPE: Housing units, Take-up housing units, Cast iron housing, Radial insert ball bearing with eccentric locking collar, With inner ring extended at one side, for tensioning frame, stainless steel

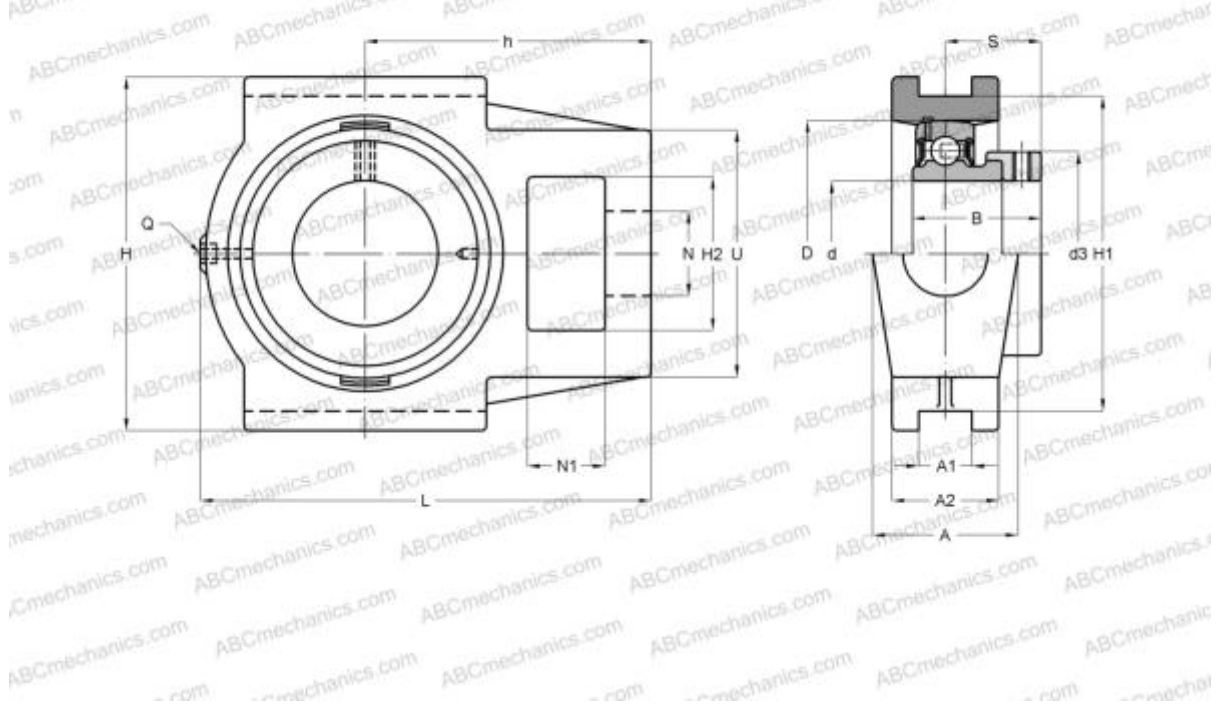

Technical specification

DIMENSIONS, MM

d	17,000
D	40,000
B	28,600
L	94,000
H	89,000
A	32,000
H2	32,000
A1	12,000
A2	21,000
H1	76,000
N	19,000
N1	16,000
S	22,600
d3	28,600
U	51,000

DIMENSIONS, MM

h	61,000
---	--------

WEIGHT, KG

	0,740
Bearing	SES203
Housing	ST204

MANUFACTURER

[SNR](#)

INTERCHANGE

ABC	SEST203
-----	-------------------------

CALCULATION DATA

Operating temperature min	-20 °C
Operating temperature max	120 °C