

SEST205 SNR

Ball bearing units

TYPE: Housing units, Take-up housing units, Cast iron housing, Radial insert ball bearing with eccentric locking collar, With inner ring extended at one side, for tensioning frame, stainless steel

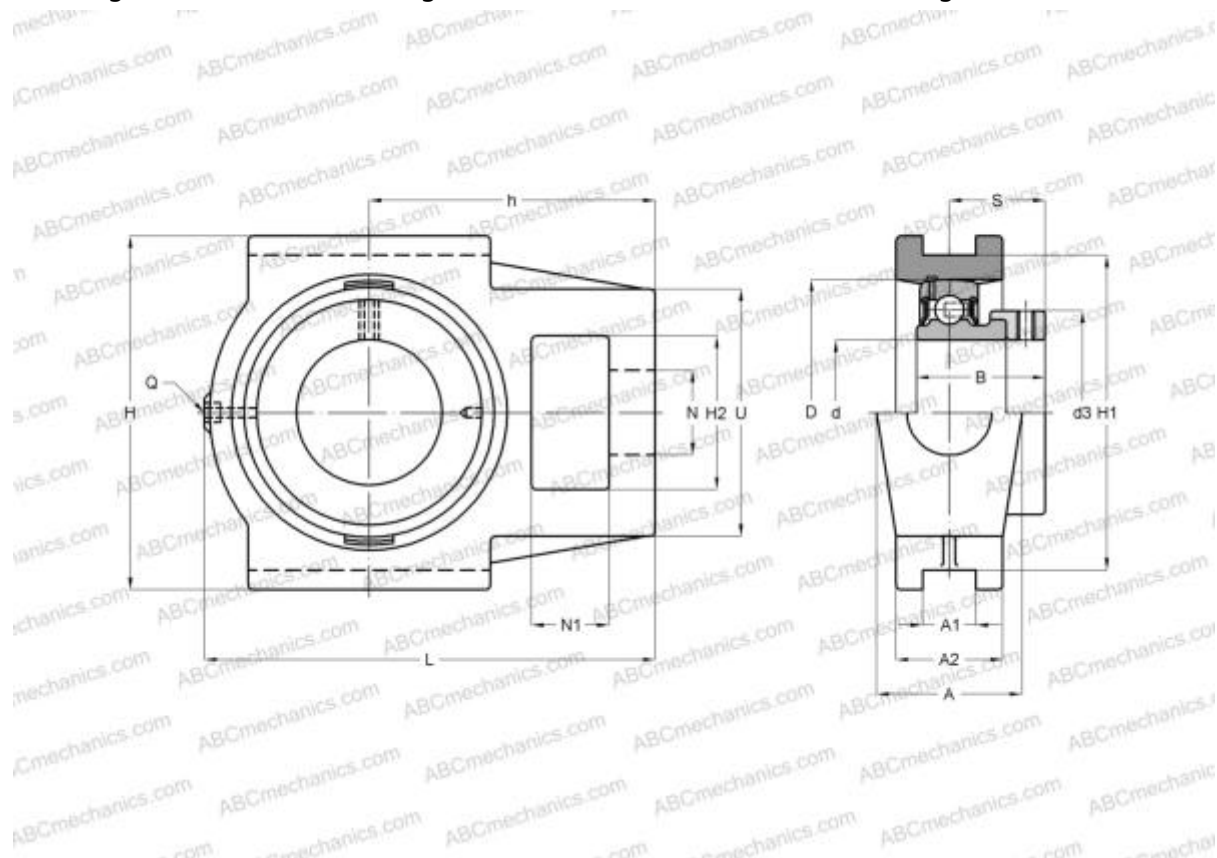

Technical specification

DIMENSIONS, MM

d	25,000
D	52,000
B	31,000
L	97,000
H	89,000
A	32,000
H2	32,000
A1	12,000
A2	24,000
H1	76,000
N	19,000
N1	16,000
S	23,500
d3	38,100
U	51,000

DIMENSIONS, MM

h	62,000
---	--------

WEIGHT, KG

	0,880
Bearing	SES205
Housing	ST205

MANUFACTURER

[SNR](#)

INTERCHANGE

ABC	SEST205
-----	-------------------------

CALCULATION DATA

Operating temperature min	-20 °C
Operating temperature max	120 °C