

SEST206-19 SNR

Ball bearing units

TYPE: Housing units, Take-up housing units, Cast iron housing, Radial insert ball bearing with eccentric locking collar, With inner ring extended at one side, for tensioning frame, stainless steel, inch size

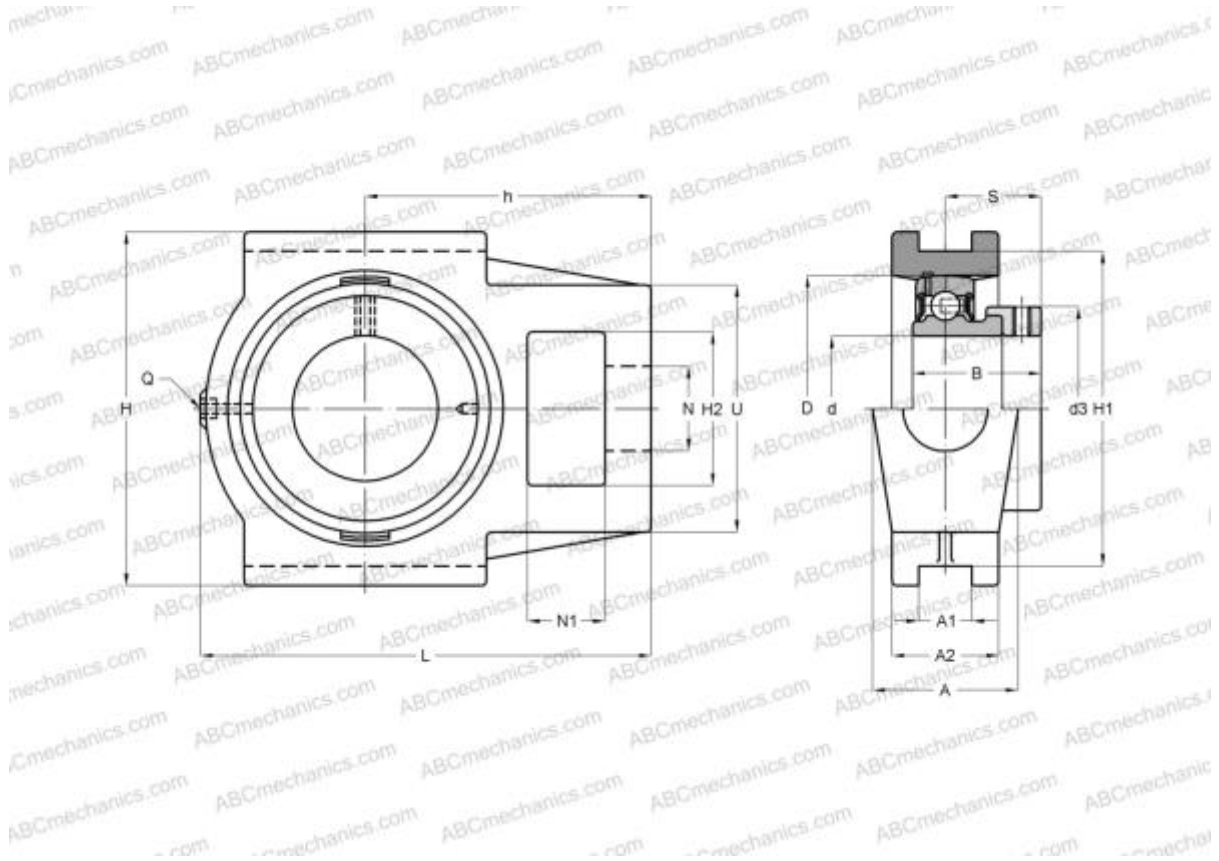

Technical specification

DIMENSIONS, MM

d	30,163
D	62,000
B	35,700
L	113,000
H	102,000
A	37,000
H2	37,000
A1	12,000
A2	28,000
H1	89,000
N	22,000
N1	16,000
S	27,700
d3	44,500
U	56,000

DIMENSIONS, MM

h	70,000
---	--------

WEIGHT, KG

Bearing	SES206-19
Housing	ST206

MANUFACTURER

[SNR](#)

CALCULATION DATA

Operating temperature min	-20 °C
Operating temperature max	120 °C