

SEST209-28 SNR

Ball bearing units

TYPE: Housing units, Take-up housing units, Cast iron housing, Radial insert ball bearing with eccentric locking collar, With inner ring extended at one side, for tensioning frame, stainless steel, inch size

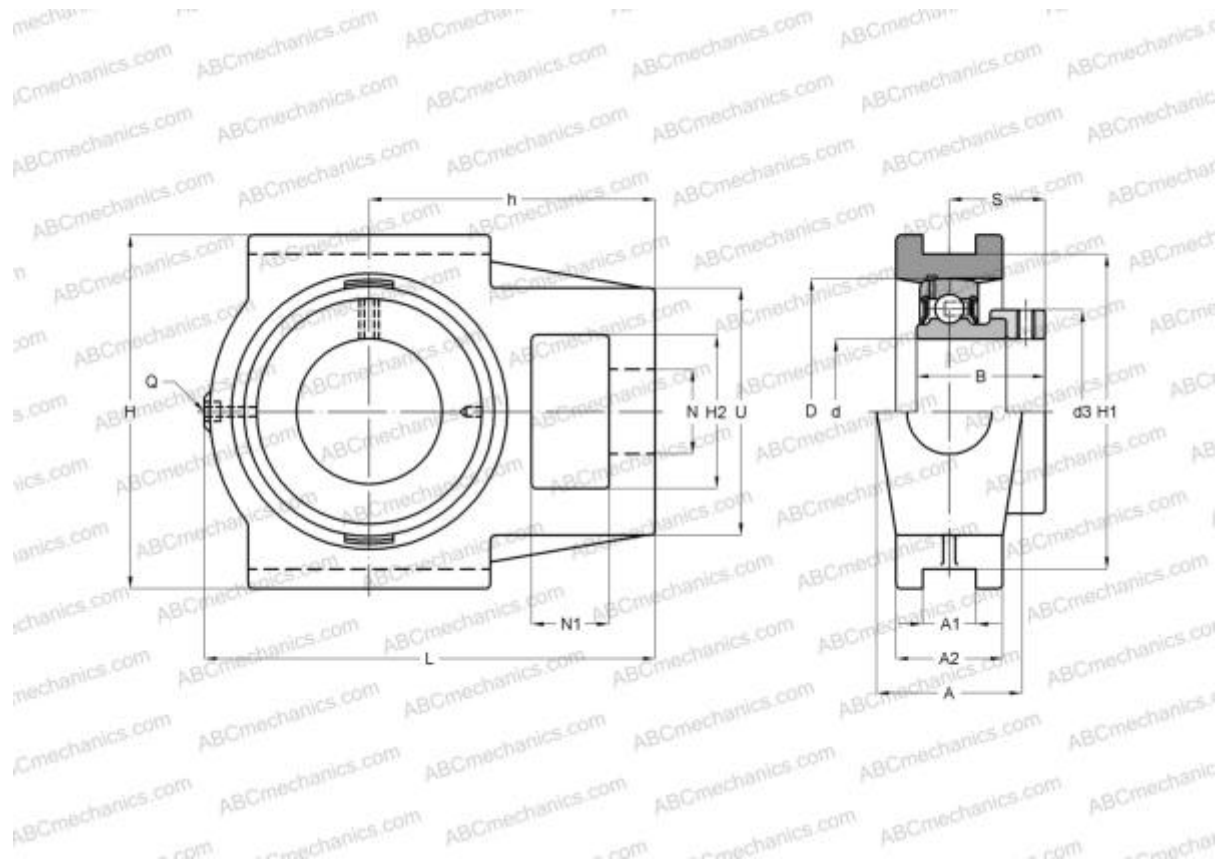

Technical specification

DIMENSIONS, MM

d	44,450
D	85,000
B	43,700
L	144,000
H	117,000
A	49,000
H2	49,000
A1	16,000
A2	35,000
H1	102,000
N	29,000
N1	19,000
S	34,200
d3	63,500
U	83,000

DIMENSIONS, MM

h	87,000
---	--------

WEIGHT, KG

Bearing	SES209-28
Housing	ST209

MANUFACTURER

[SNR](#)

CALCULATION DATA

Operating temperature min	-20 °C
Operating temperature max	120 °C