

## SUCT203 ABC

Ball bearing units

TYPE: Housing units, Take-up housing units, Cast iron housing, Radial insert ball bearing with grub screws in inner ring, With inner ring extended on both sides, for tensioning frame, stainless steel

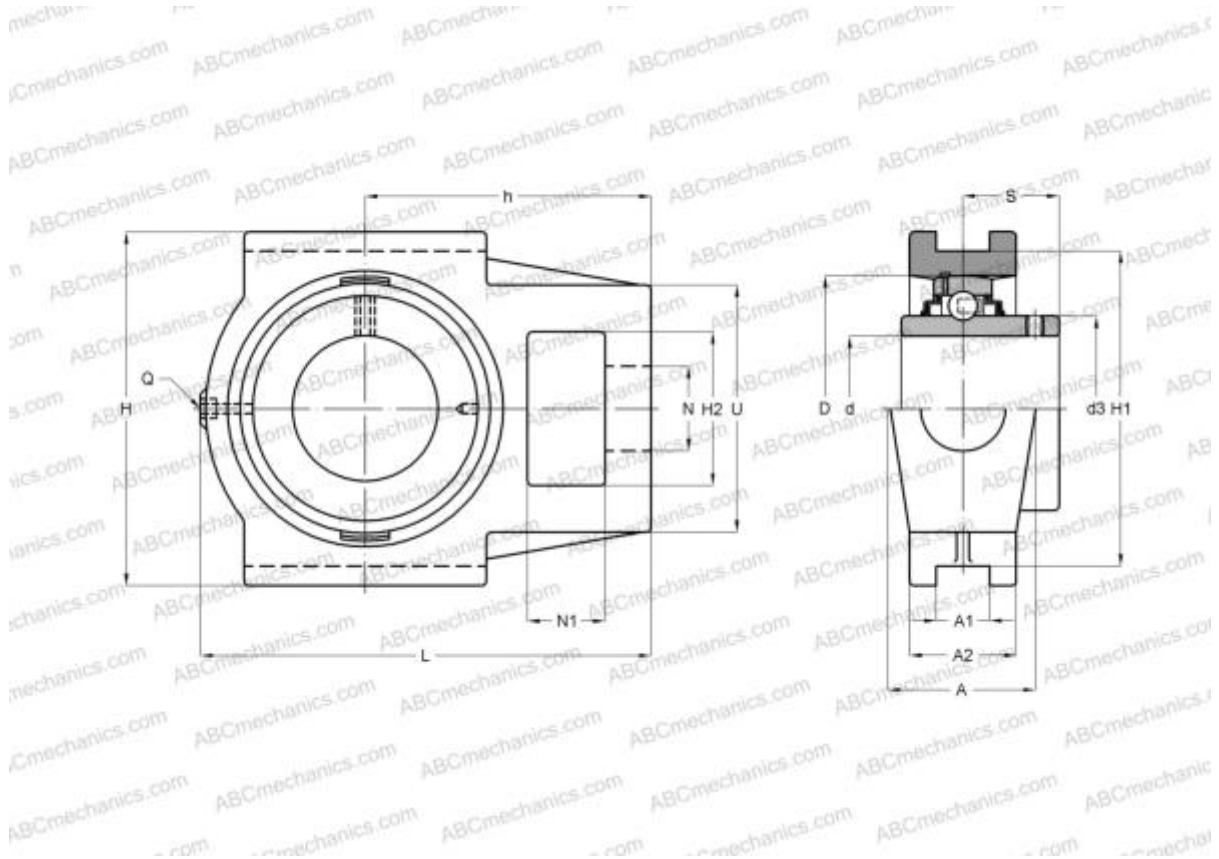

### Technical specification

#### DIMENSIONS, MM

d	17,000
D	47,000
B	31,000
L	94,000
H	89,000
A	32,000
H2	32,000
A1	12,000
A2	21,000
H1	76,000
N	19,000
N1	16,000
S	18,300
U	51,000
h	61,000

#### WEIGHT, KG

	0,810
Bearing	SUC203
Housing	ST204

#### MANUFACTURER

[ABC](#)

#### INTERCHANGE

SNR	<a href="#">SUCT203</a>
-----	-------------------------